



AV over IP

# User Manual

---

Model : HKM02B-4K6G

4K60Hz HDMI USB/Audio/RS232/IR KVM over IP Extender



# Table of Contents

- Introduction..... 4**
- Features..... 5**
- Application Diagram..... 6**
  - Point to point application..... 6
  - AV over IP distribution system..... 7
  - Videowall application..... 8
- Panel View..... 9**
  - HKM02BT-4K6G..... 9
  - HKM02BR-4K6G..... 11
  - Panel LED Indication..... 13
    - Front Panel LED Indication..... 13
    - Front Panel MSG Indication (System error, warning signals)..... 14
    - Back Panel RJ45 LED Indication..... 14
    - Back Panel SFP LED Indication..... 15
- Functional Description..... 16**
  - Communication Methods..... 16
    - Unicast Mode..... 16
    - Multicast Mode..... 17
  - KVM Transmission over IP..... 18
    - Bandwidth..... 18
    - Latency..... 18
    - Transmission Distance..... 19
    - RJ45 Pin Definition..... 19
  - KVM Transmission over Fiber Optic..... 20
    - Transmission Distance..... 20
    - SFP Pin Definition..... 20
    - Fiber Connector Type..... 21
  - Pairing..... 22
    - Grouping..... 22
      - One to one pairing..... 22
      - One to many grouping..... 22
      - Many to one grouping..... 24
      - Many to many grouping..... 24
  - Default Setting..... 24
    - Reset to Factory Settings..... 24
    - Default IP Address..... 25

SFP/ Ethernet Link – Detection Mode.....	26
Switch Requirements.....	26
Video Interface.....	28
Support Resolution.....	28
Audio Interface.....	29
Digital/Analog Audio Conversion.....	29
Bidirectional Audio Transmission.....	29
USB Interface.....	33
Read and write speed.....	33
USB Compatibility.....	35
USB Storage.....	35
USB Power Output.....	36
RS232 interface.....	37
RS232 Passthrough.....	37
Control Transmitter and Receiver through RS232.....	38
Infrared (IR) Interface.....	39
<b>Control via Front Panel Buttons.....</b>	<b>40</b>
Function Description.....	40
Channel Selection.....	40
Menu Selection.....	41
Button Function List.....	42
<b>Control via IR Remote.....</b>	<b>43</b>
Function Description.....	43
Setting up the Remote ID.....	43
Channel Selection.....	43
Menu Selection.....	44
Enter/Exit Quick Blocking Mode.....	44
Screensaver wake-up.....	44
Add/Remove Favorite List for Receiver.....	44
Videowall/General Mode switching for Receiver.....	44
Turn on/off video output of Receiver.....	45
Connection/Disconnection of Transmitter.....	45
RS232 OSD Display for Transmitter.....	45
Basic Button Function List.....	45
Advanced OSD Menu Function List.....	47
<b>Control via RS232.....</b>	<b>53</b>
Function Description.....	53

- Command List..... 55
- Control via Web GUI..... 62**
  - System..... 62
  - Video Wall..... 63
  - Network..... 70
  - Function..... 71
    - Transmitter..... 71
      - Video over IP Settings..... 71
      - USB over IP Settings..... 72
      - Serial over IP Settings..... 73
    - Receiver..... 74
      - Video over IP Video Settings..... 74
      - USB over IP Settings..... 75
      - Serial over IP Settings..... 76
- Accessory..... 77**
  - Compatible with: SR01X - Gigabit Repeater..... 77
  - Keypad: Other Control method..... 78
- Technical Specification..... 79**
- Caution..... 81**
- Package Includes..... 82**
- Installation..... 83**
  - Installed on Wall..... 83
  - Installed on a Rack..... 83
  - Installed on Platform..... 84

## Introduction

HKM02B-4K6G uses AV over IP technology to route up to 1000 4K60Hz HDMI® sources to up to 60000 display over IGMP and jumbo frame protocol gigabit switches, which can achieve HDMI® signal extending, distributing, switching and routing. Additionally, the boundless switching function allows you to use one mouse to operate multiple PCs by moving the mouse cursor across the monitor's borders. HKM02B-4K6G is a multifunctional system that integrates multiple media. You can perfectly apply it to large-scale security rooms, classrooms, trading rooms, and many more.

## Features

- Resolution up to 4K60Hz 4:4:4
- Signal extension up to 100m over CAT5e (or greater), 60km over fiber optic cable
- Workable with Ethernet switches for HDMI® extension, distribution, switching and matrix
- Built-in loop out, an extra local HDMI® display at transmitter side
- Built-in 4 USB ports for remote control at receiver side
- PoE powered (HKM02BP-4K6G)
- Supports video sub-stream
- Supports videowall
- Supports video scaler, 4K to 1080p/1080p to 4K
- Supports HDMI® audio embedding and extraction
- Supports image rotation
- Supports RS232 signal distribution
- Workable with SR01X for longer distance
- Managed via Windows, Android/iOS app, WebGUI, IR remote, panel buttons, RS232 console and telnet API

### Application Diagram

#### Point to point application

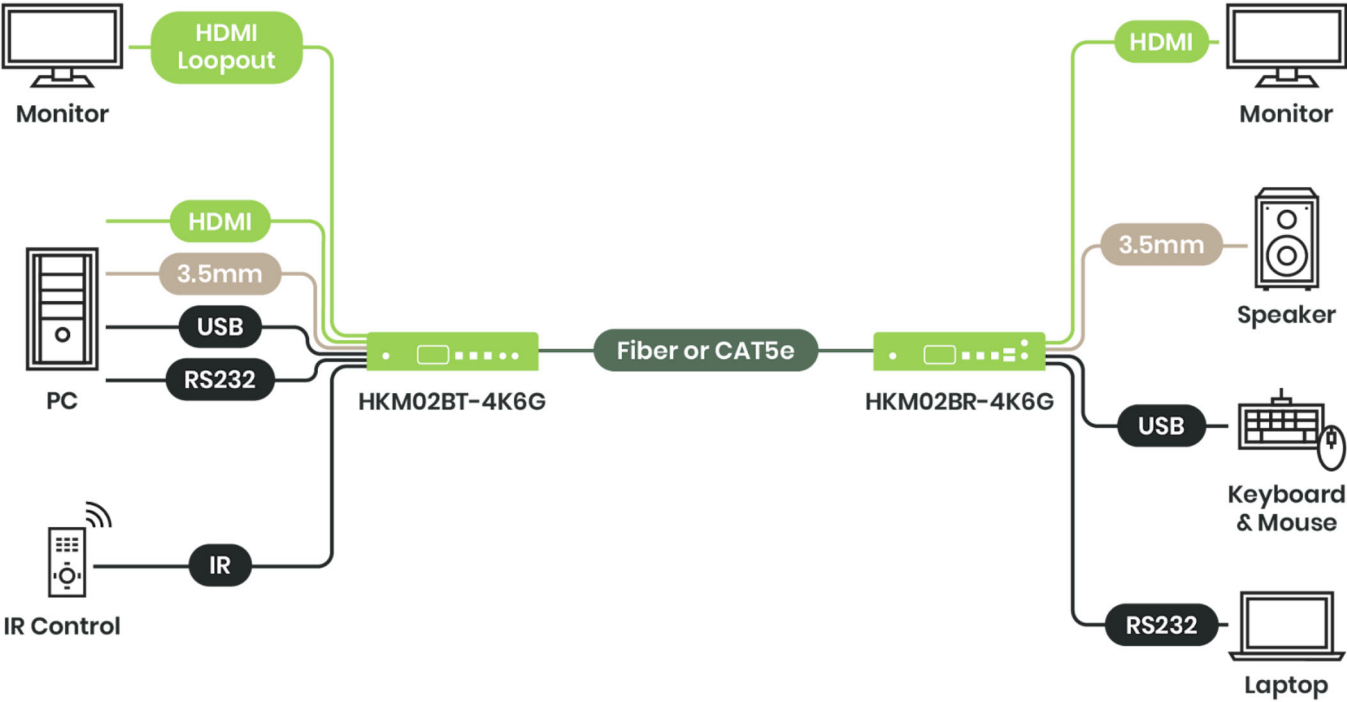

AV over IP distribution system

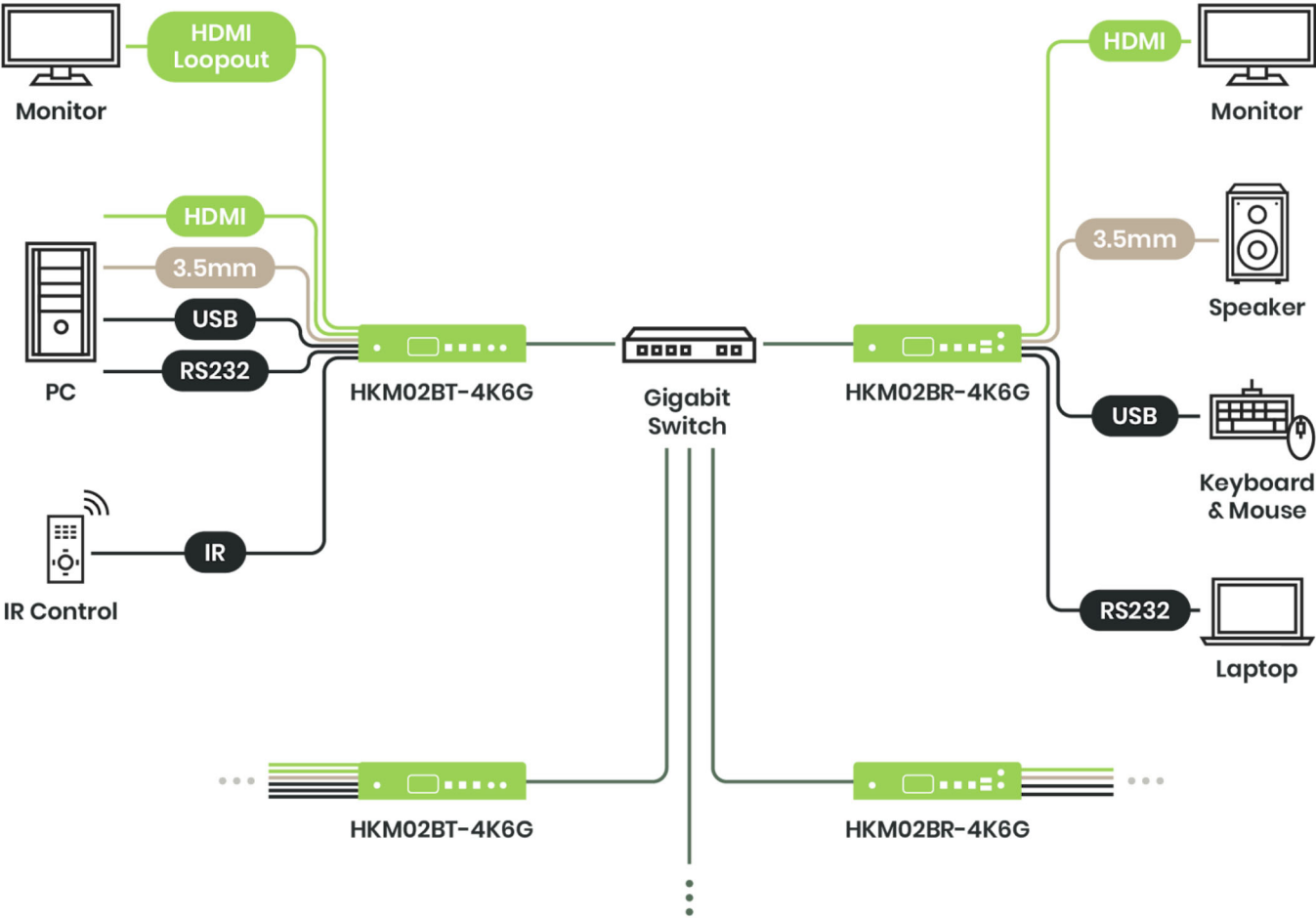

Videowall application

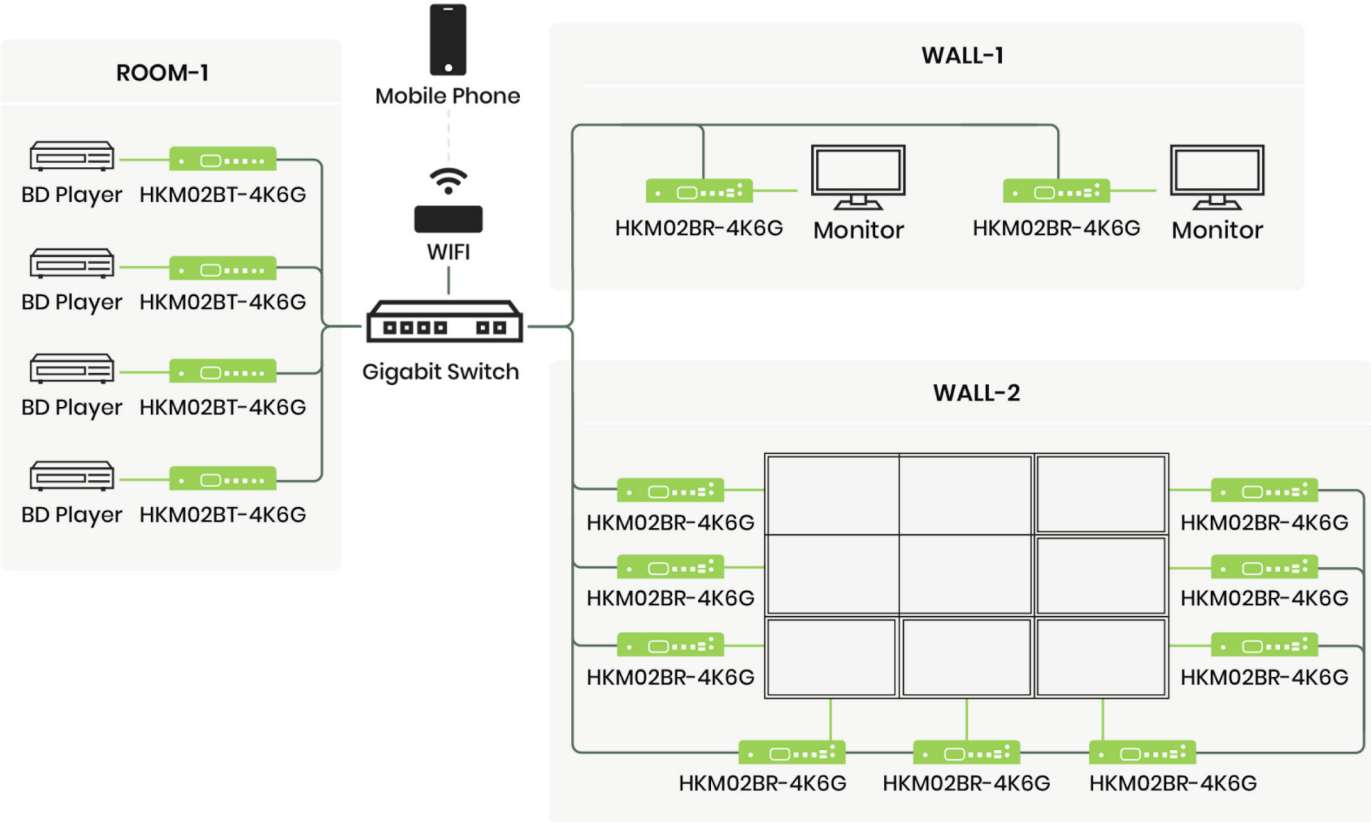



Panel View

HKM02BT-4K6G

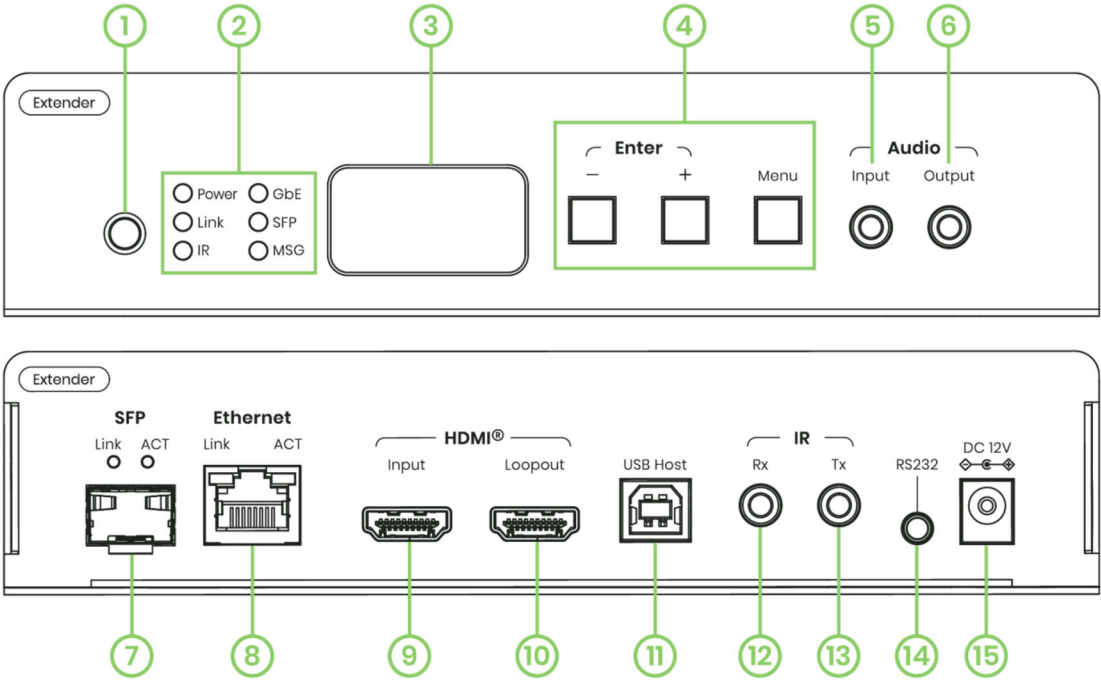

Item	Interface	Description
1	Built-in IR receiver	To receive IR signals. If IR Rx is connected to an IR receiver, the built-in IR receiver will be disabled
2	LED indication	See <b>Panel LED Indication</b>
3	Channel display	3 digits showing the Channel or Menu number
4	Panel Buttons	See <b>Control via Front Panel</b>
5	Audio Input	To connect to an audio source
6	Audio Output	To connect to an audio receiver
7	SFP Fiber Connector	To connect to HKM02BR-4K6G or a switch via SFP fiber module
8	Ethernet	To connect to HKM02BR-4K6G or a switch via Ethernet cable
9	HDMI® Input	To connect to an HDMI® source
10	HDMI® Loopout	To connect to a monitor or TV
11	USB Host	To connect to a USB Host
12	IR Rx	To connect to an IR receiver
13	IR Tx	To connect to an IR emitter
14	RS232	To connect to RS232-command-controller (needs 3.5mm jack cable to RS232)
15	DC Jack	To plug in DC 12V 1.5 A power adapter

## HKM02BR-4K6G

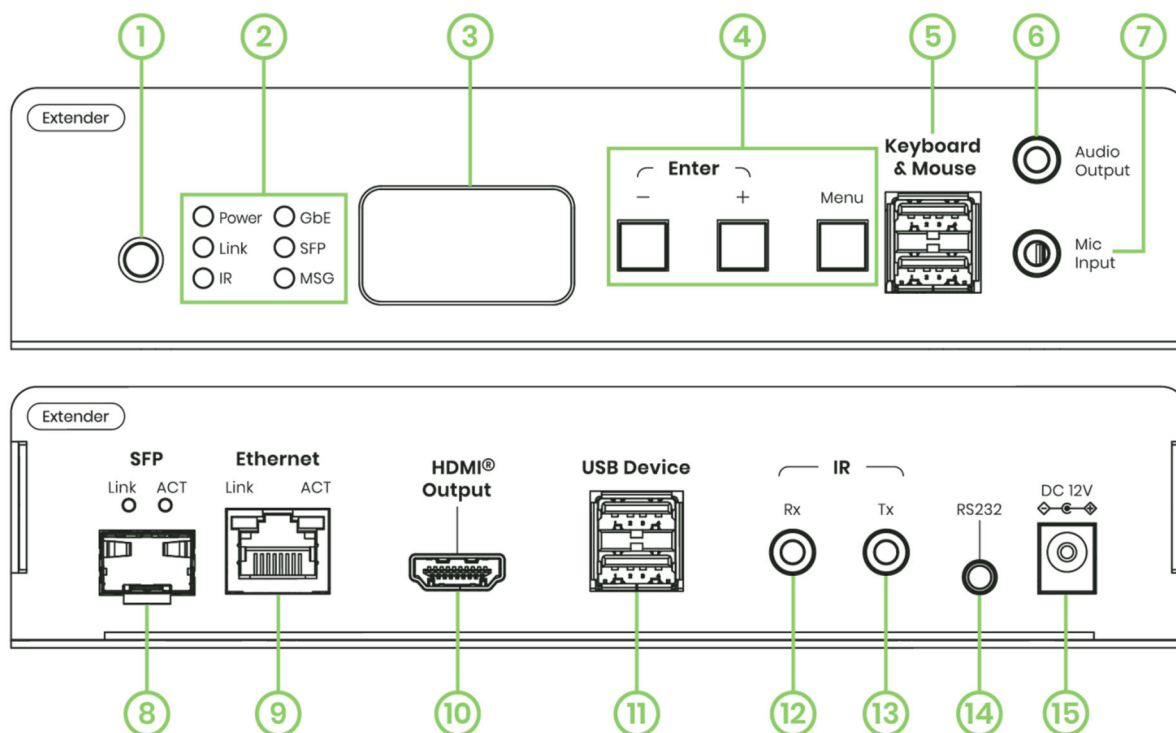

Item	Interface	Description
1	Built-in IR receiver	To receive IR signals. If IR Rx is connected to an IR receiver, the built-in IR receiver will be disabled
2	LED Indication	See <b>Panel LED Indication</b>
3	Channel display	3 digits showing the Channel or Menu number
4	Panel Button	See <b>Control via Front Panel</b>
5	Keyboard & Mouse	To connect to USB devices (USB 1.1). Keyboard & mouse only
6	Audio output	To connect to an audio receiver
7	Audio Input (Mic)	To connect to a microphone
8	SFP Fiber Connector	To connect to HKM02BT-4K6G or a switch via SFP fiber module
9	Ethernet	To connect to HKM02BT-4K6G or a switch via Ethernet cable
10	HDMI® output	To connect to a monitor or TV
11	USB Device	To connect to a USB device, compatible with USB2.0/1.1/1.0
12	IR Rx	To connect to an IR receiver
13	IR Tx	To connect to an IR emitter
14	RS232	To connect an RS232-command-controllable device (needs 3.5mm jack cable to RS232)
15	DC Jack	To plug in DC 12V 1.5 A power adapter

Panel LED Indication

Front Panel LED Indication

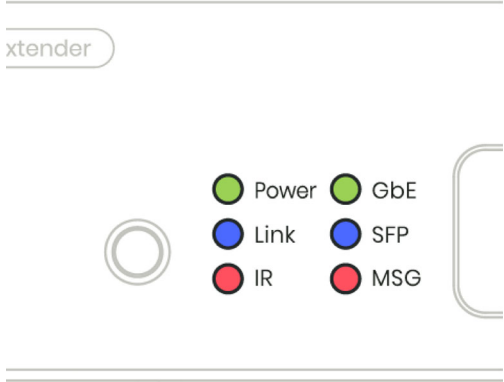

Panel LED	Status	HKM02B-4K6G
Power (Green)	On	Boot completed
	Flash Twice	Booting
	Flash Slowly	HKM02BT-4K6G (Transmitter): Stop linking HKM02BR-4K6G (Receiver): Video output being turned off
Link (Blue)	On	Connected & video is streaming
	Flash	Connecting, or no source input from the transmitter
IR (Red)	On	Transmitting/receiving an IR signal
GbE (Green)	On	Connected by the Ethernet RJ45 port
	Flash	Transmitting/receiving data from the Ethernet RJ45 port
SFP (Blue)	On	Connected by the SFP fiber port
	Flash	Transmitting/receiving data from the SFP fiber port
MSG (Red)	On	Other messages (IR, RS232, system settings, etc)
	Flash 2~9 Times	System warning or alert. (See <i>Front Panel MSG Display</i> )

Front Panel MSG Indication (System error, warning signals)

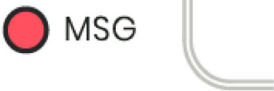

Flashed Times	HKM02B-4K6G MSG LED
Always ON	IR control, RS232 control, system settings
2	IR control disabled
3	Transmitter channel conflicts
4	DHCP server not found
5	Reset to factory default
6	Engineering mode / Firmware update mode
7	Manufacturer setting mode
8	Aux system stopped
9	Aux system firmware boot sector error
10	Aux system firmware type error

**Back Panel RJ45 LED Indication**

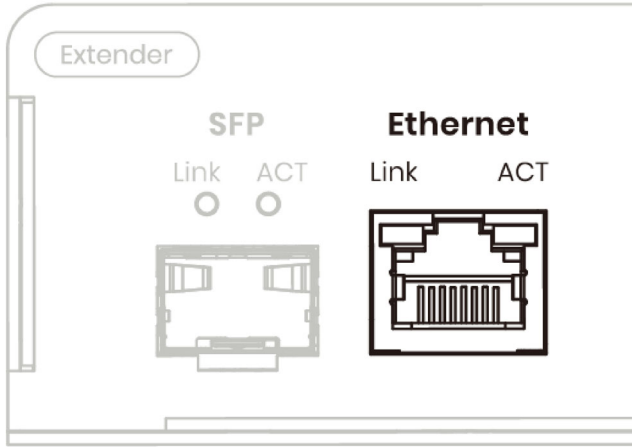

LED	Status	Description
Link <b>(Green)</b>	On	Ethernet interface connected
ACT <b>(Orange)</b>	Flash	Transmitting data through the Ethernet interface

**Back Panel SFP LED Indication**

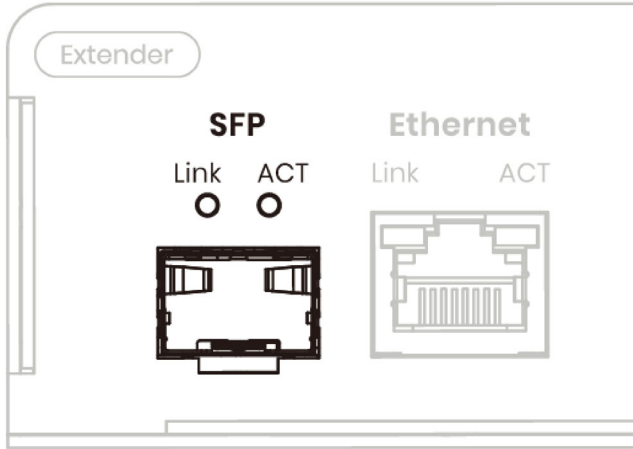

LED	Status	Description
Link <b>(Green)</b>	On	SFP fiber interface connected
ACT <b>(Orange)</b>	Flash	Transmitting data through the SFP fiber interface

## Functional Description

### Communication Methods

HKM02B-4K6G supports two primary communication methods for audiovisual (AV) over IP: unicast and multicast. Understanding these methods is crucial for optimizing your network setup and ensuring the best performance and reliability for your AV over IP applications.

#### Unicast Mode

Unicast communication is a one-to-one transmission where data is sent from one single sender to one single receiver. This method is typically used in point-to-point connections and is ideal for scenarios where a specific device needs to receive from another specific device.

In this mode, bi-directional analog audio transmission is supported.

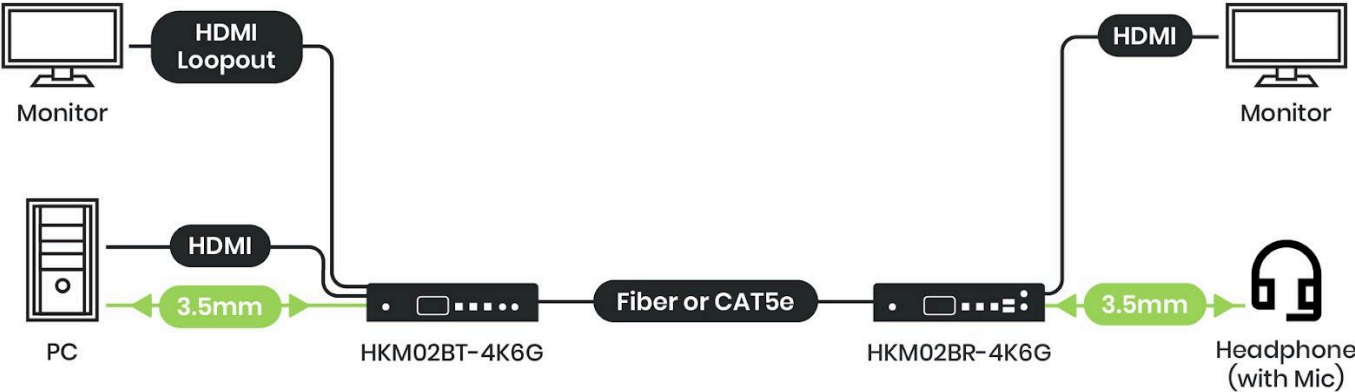

Multicast Mode

Multicast communication can be one-to-one, one-to-multiple, or multiple-to-multiple transmission. This method is optimal for scenarios where data needs to be distributed to several devices.

The default mode is set to multicast.

In this mode, bi-directional analog audio transmission is not possible, the analog audio data can be transmitted only from the transmitter to the receiver.

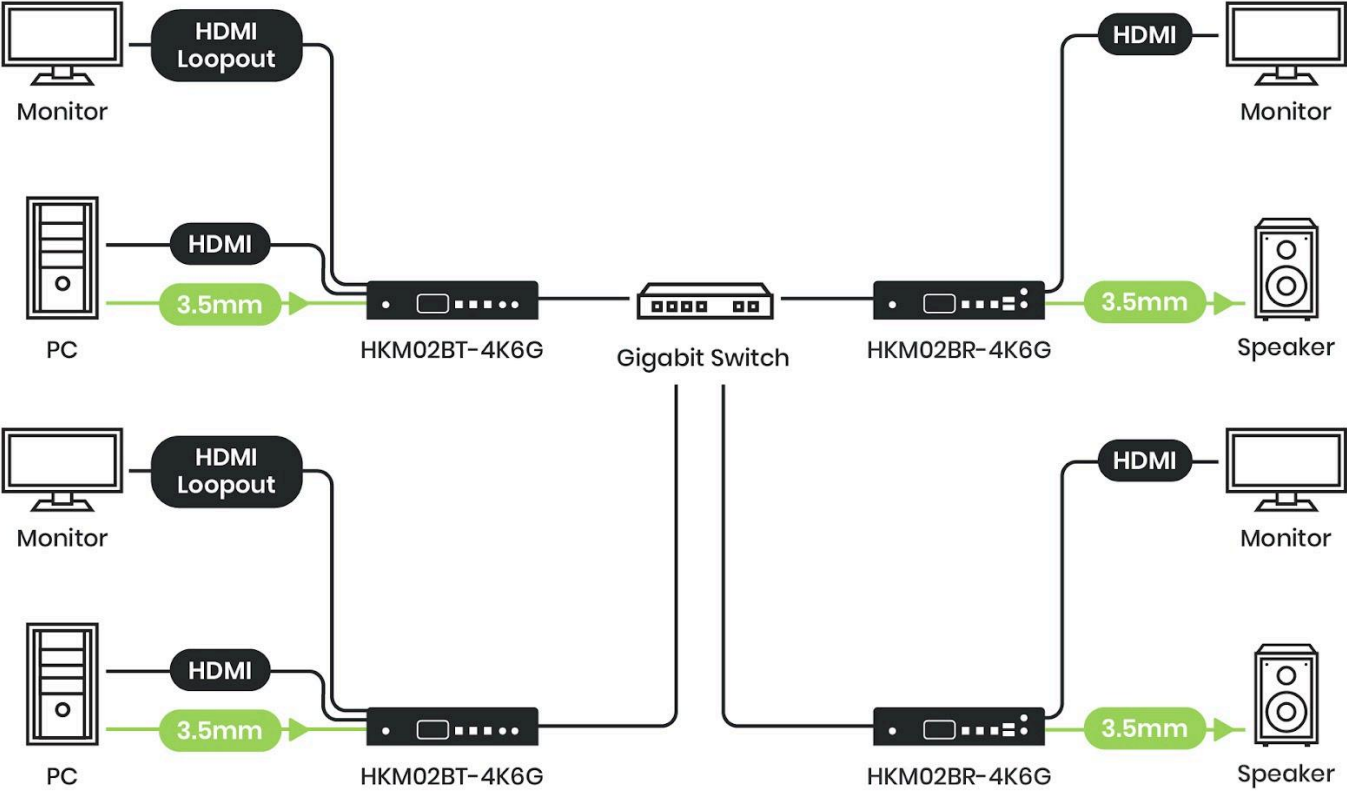

## KVM Transmission over IP

HKM02B-4K6G allows Keyboard, Video, and Mouse (KVM) transmission over IP using advanced technologies which enables the encoding and decoding of AV signals into IP packets for transmission over Ethernet cables or fiber optic connections, allowing for longer reach distance without compromising signal quality.

### Bandwidth

The compression algorithms employed by the codec reduce the size of AV data, allowing for efficient transmission over 1 Gigabit Ethernet networks.

The bandwidth will vary based on different resolutions. A higher resolution may not require a higher bandwidth. Below table shows the average bandwidth according to the resolution being used:

Resolution	Quality Level	Max Frame Rate	Average Bandwidth (Mbps)
3840x2160 (2160p60)	Auto	60	442 (93~830)
3840x2160 (2160p30)	Auto	30	261 (92~423)
1920x1080 (1080p)	Auto	60	187 (99~525)
1280x720 (720p)	Auto	60	119 (78~330)

The above table, as a reference, does not include the bandwidth consumed by the USB transmission, which will add up to approximately 50 Mbps when transferring data.

### Latency

HKM02B-4K6G has a latency<sup>1</sup> of approximately one frame according to our test, and here is our test condition. The test result is shown as follows:

HKM02B-4K6G Latency Test			
Test condition			Test result
Distance	Resolution	Cable used	
100m	4K60Hz 4:4:4	CAT5e COMMSCOPE ISO-EN COMPLIANT 27 CAT5E UTP SOLIDPR04 AWG 24 1917 RN19040036	Around 1 frame

<sup>1</sup> The compression introduces ultra-low latency which is crucial for real-time applications such as video conferencing and live streaming, where minimizing delay is essential for smooth and responsive communication.



**Transmission Distance**

At 4K60Hz 4:4:4, HKM02B-4K6G could reach up to 100m, the distance may differ by cable or construction quality. The transmission distance test result is shown as follows:

HKM02B-4K6G Transmission Distance Test		
Test condition		Test result
Resolution	Cable used	
4K60Hz 4:4:4	CAT5e COMMSCOPE ISO-EN COMPLIANT 27 CAT5E UTP SOLIDPR04 AWG 24 1917 RNI9040036	100m
4K60Hz 4:4:4	CAT6 COMMSCOPE E98256 4PR 24AWG U/UTP	170m

**RJ45 Pin Definition**

RJ45 connectors are commonly used for Ethernet cables in networking and AV over IP applications. Understanding the pinout or pin configuration of the connector is essential for proper cable termination<sup>2</sup> and connectivity.

Pin	Color	Data
1	Orange-white	DATA0 +
2	Orange	DATA0 -
3	Green-white	DATA1 +
4	Blue	DATA2 +
5	Blue-white	DATA2 -
6	Green	DATA1 -
7	Brown-white	DATA3 +
8	Brown	DATA3 -

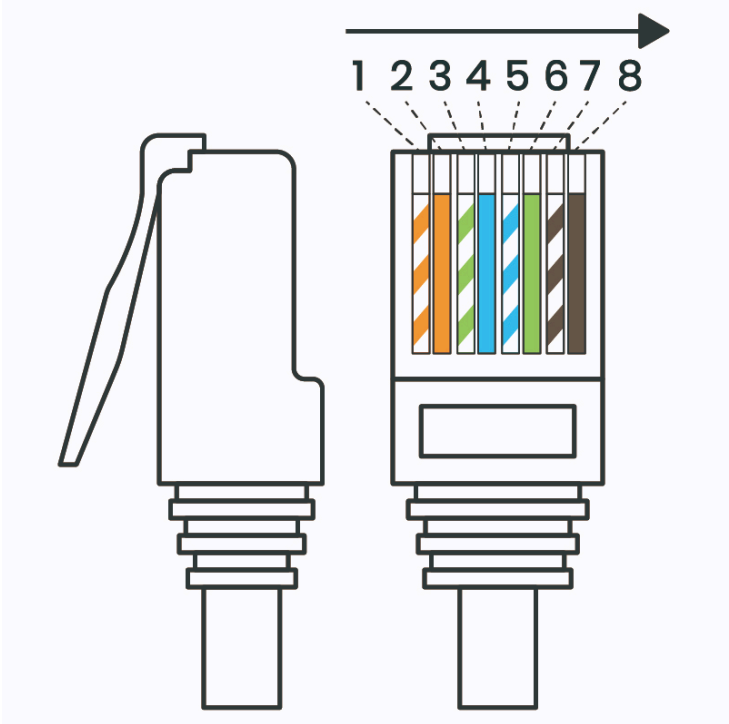

<sup>2</sup> When terminating Ethernet cables with RJ45 connectors, it's crucial to follow the TIA/EIA-568 wiring standards, which specify the wiring scheme for T568B pinout.

## KVM Transmission over Fiber Optic

HKM02B-4K6G also offers KVM transmission over longer distances using fiber optic cables.

Depending on the specific SFP (Small Form-factor Pluggable) modules and fiber optic cables used, transmission distances can extend from hundreds of meters to several kilometers without signal degradation.

HKM02BT-4K6G converts electrical AV signals into optical signals by the SFP transmitter module for transmission over fiber optic cables, while HKM02BR-4K6G converts optical signals back into electrical AV signals with the SFP receiver module at the receiving end.

HKM02B-4K6G is compatible with both single-mode and multi-mode SFP fiber modules, offering flexibility in deployment based on distance requirements and installation environments.

When using multiple HKM02BT-4K6Gs and HKM02BR-4K6Gs with fiber optics, you need to connect the transmitters and receivers to an Ethernet switch with SFP.

### Transmission Distance

HKM02B-4K6G optional package includes a pair of SFP transceiver modules. Single-mode modules, FM01S-20K, can be used when distances up to 20 kilometers are needed, while multi-mode modules, FM01M-550 are used for shorter distances up to 300 meters.

### SFP Pin Definition

HKM02B-4K6G meets the pin configuration of SFP modules which adheres to industry standards governed by the Multi-Source Agreement (MSA). The SFP MSA outlines mechanical, electrical, and functional specifications for SFP modules, including the pin out configuration, ensuring interoperability and compatibility with SFP compatible devices from different manufacturers. Below tables is the pin configuration for SFP transceivers.

Pin	Pin Name	Description
1	Vee	Ground connection
2	TX_FAULT	Indicates a fault condition in the transmitter
3	TX_DISABLE	When pull low, disables the transmitter circuitry
4	MOD_DEF2	Used for module identification and management purposes
5	MOD_DEF1	Used for module identification and management purposes
6	MOD_DEF0	Used for module identification and management purposes
7	Rate Select	No connection required
8	RX_LOS	Indicates the loss of signal condition on the receiver side
9	Vee	Ground connection
10	Vee	Ground connection
11	Vee	Ground connection

12	RD-	Differential pair for receiving data signals
13	RD+	Differential pair for receiving data signals
14	Vee	Ground connection
15	Vcc	Provides power to the SFP module
16	Vcc	Provides power to the SFP module
17	Vee	Ground connection
18	TD+	Differential pair for transmitting data signals
19	TD-	Differential pair for transmitting data signals
20	Vee	Ground connection

Bidirectional Small Form-factor Pluggable (Bi-Di SFP) is also supported by HKM02B-4K6G. Unlike traditional SFP modules, which use separate fibers for transmitting and receiving data (one for each direction), Bi-Di SFP modules utilize wavelength division multiplexing (WDM) technology to transmit and receive signals over the same fiber strand.

#### Fiber Connector Type

The SFP modules provided in our optional package use Lucent Connector (LC) type dual fiber connectors for seamless integration with existing fiber optic infrastructure. The LC connector's small form-factor and dual fiber design enable high-density connections and efficient use of fiber optic cables in networking environments.

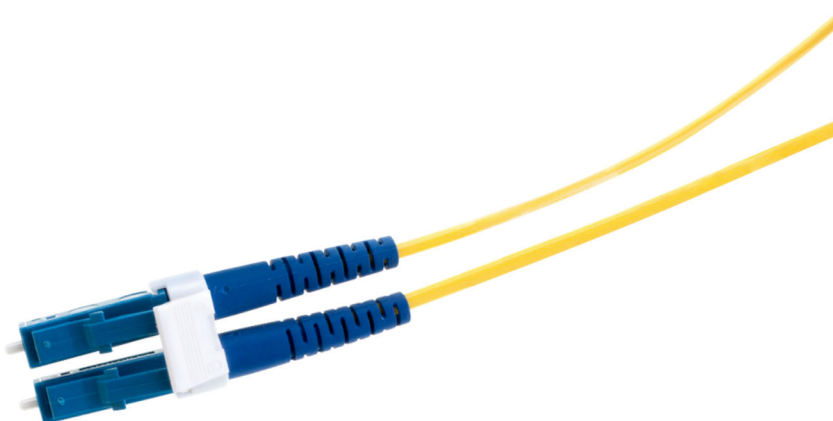

**Pairing**

Pairing the HKM02B-4K6Gs is essential for transmitting and receiving audiovisual signals over IP networks. To ensure proper functionality and communication between transmitters and receivers, follow below steps.

Grouping

- 1. You only need to set the channels when connecting multiple HKM02BT-4K6Gs/HKM02BR-4K6Gs to the same Ethernet switch.
- 2. Set up the channel using one of the following methods:
  - 2.1. Front Panel Buttons (refer to "Control via Front Panel")
  - 2.2. IR Remote (refer to "Control via IR Remote")
  - 2.3. RS232 command (refer to "Control via RS232")
  - 2.4. Software Application

The channel of the transmitter and receiver in the same group should be the same. Note that each HKM02BT-4K6G should be assigned a unique channel number (no channels should be repeated).

*One to one pairing*

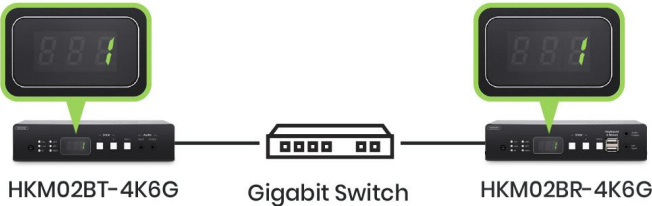

*One to many grouping*

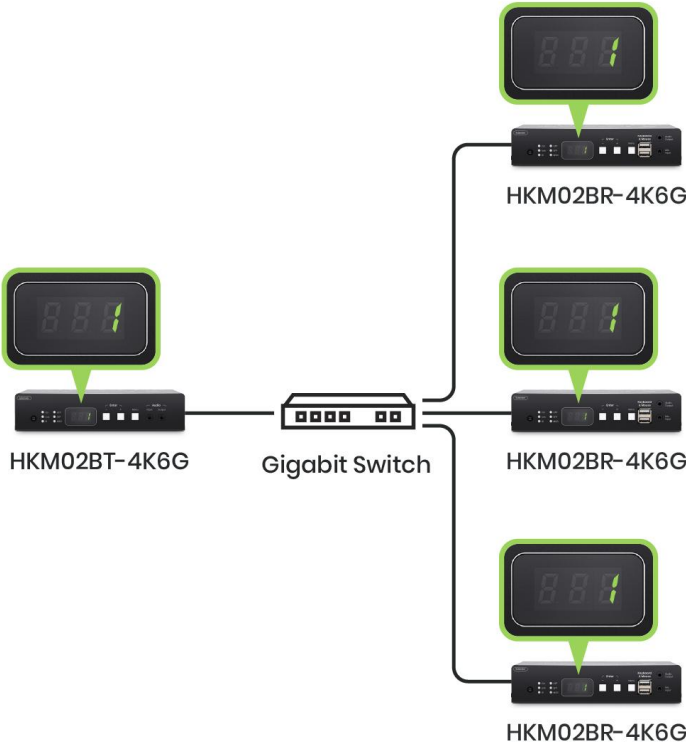

Many to one grouping

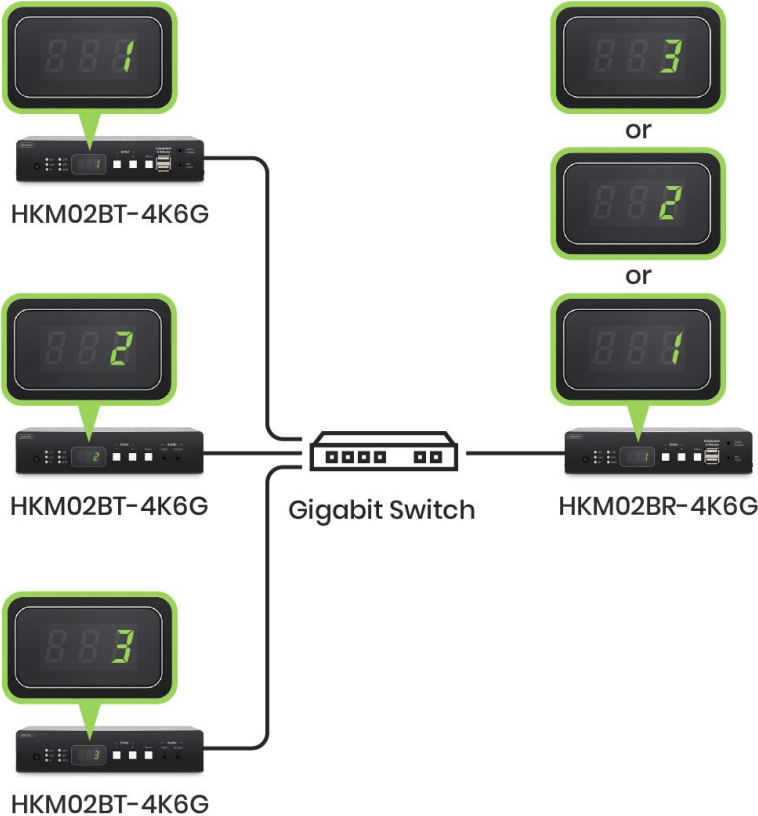

Many to many grouping

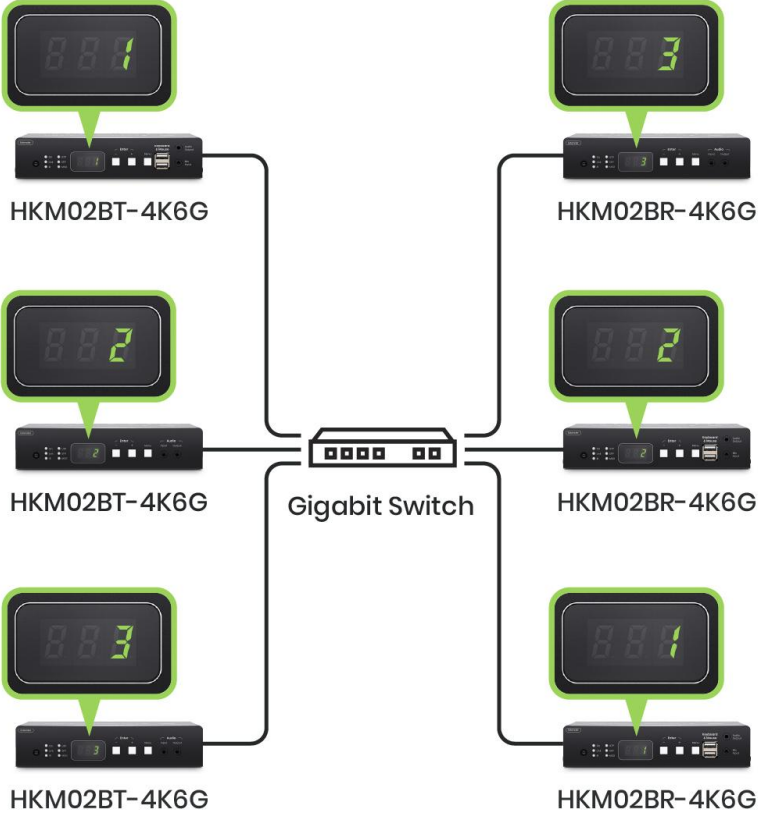

## Default Setting

### *Reset to Factory Settings*

HKM02B-4K6G has two different methods to reset its settings to the default factory settings:

1. While powered-off, press and hold the channel button “-” on the front panel, and then power on. The power and link LEDs will be flashing for a few seconds indicating that the resetting is successfully done.
2. While powered-on, press the following control buttons (via IR remote or panel buttons):



The default communication mode is set to multicast mode.

The system default IP is set to a Static IP, belonging to a network segment of 169.254.x.x, where the last four digits (HEX) maps the last four digits of the MAC address, e.g: if the MAC address is xx:xx:xx:xx:12:AB, then the IP address will be 169.254.18.171.

The default setting can be modified to DHCP or Auto IP, please refer to the **Control Via Web GUI chapter**. While Auto IP is used, the last four digits of the IP address will be assigned randomly with the same network segment of 169.254.x.x (subnet mask: 255.255.0.0) to the transmitters and receivers without DHCP server.

We suggest setting a Static IP when using Software applications or WebGUI to prevent network issues caused by IP address conflicts or changes.

### *Default IP Address*

1. Receiver
  - 1.1. Check the label at bottom of receiver with default IP

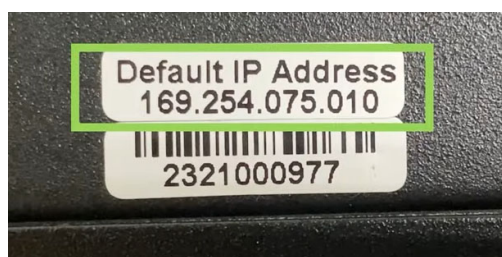

- 1.2. Connect monitor with receiver, **Local IP** shows on right bottom.

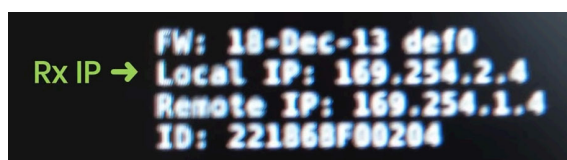

- 1.3. **MENU** by IR remote/panel button to shows IP Address on screen



2. Transmitter

- 2.1. Check the label at the bottom of the transmitter with the default IP address.

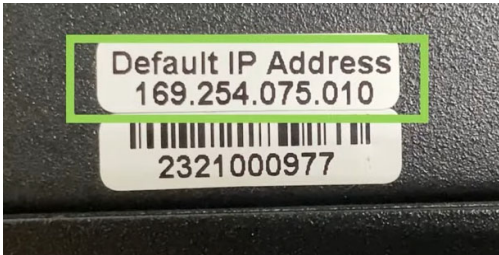

- 2.2. Connect monitor with receiver, **Remote IP** shows on right bottom.

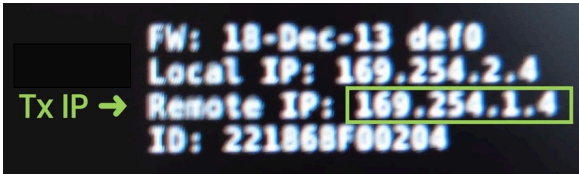

- 2.3. **MENU 6** by IR remote/panel button to shows IP Address on screen OSD

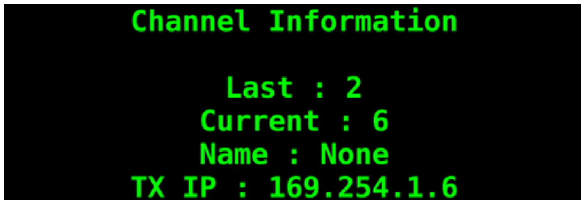

3. Reset to Default IP Address

If, for some reason, the label is blurred or removed from the bottom of the transmitter/receiver, the IP address can be reset to the default setting by the following steps:

- 3.1. If you are unsure of the IP address and the network segment of the transmitters and receivers, you can reset them to their default values.
- 3.2. To reset the device, use the IR Remote pressing the following buttons:



. Alternatively, you can press the Front Panel Button "-" while power-cycling the device..

SFP/ Ethernet Link – Detection Mode

HKM02B-4K6G will detect the connection status before booting and decide whether to use the Ethernet or fiber optic cable for transmission. We recommend you connect the cable you desire to HKM02B-4K6G before booting it.



**Ethernet Switch Requirements**

For multicast applications, a Gigabit Ethernet switch needs to be connected between transmitters and receivers. The Gigabit Ethernet switches must support the following features:

- IGMPv2 Snooping
- Jumbo frame (8000 bytes or larger)

Feature of Switch	Parameters
IGMPv2 Snooping	Enable
IGMP Querier	Disable
IGMP snooping fast leave	Enable
Jumbo Frame or (Frame Size)	set to 8000 bytes or larger

The setting of IGMP and Jumbo Frame refers to your Ethernet switch user manual.

## Video Interface

The HDMI® Video input and output functionality in HKM02B-4K6G allows for the transmission and reception of high-definition video signals over IP for longer distances. These features enable integration of HDMI®-equipped audiovisual sources and displays into the AV over IP, facilitating flexible and scalable multimedia content distribution.

### Support Resolution

HKM02B-4K6G supports various resolutions, indicated by the below table:

Resolution	
3840x2160	30/50/60Hz
2560x1600	60Hz
2560x1440	60Hz
1920x1200	60Hz
1920x1080 <sup>3</sup>	30/50/60/120Hz
1680x1050	60Hz
1600x1200	60Hz
1600x900	60Hz
1440x900	60Hz
1280x1024	60Hz
1280x720	50/60Hz
1024x768	60/75Hz
800x600	60/75Hz
640x480	60/75Hz

<sup>3</sup> The timing of 1920x1080 is also supported in interlace mode.

**Audio Interface**

Audio transmission over IP through HKM02B-4K6G enables the extension of audio signals over IP with ultra-low latency and fully synchronized with the video signal.

Apart from audio transmitted through HDMI® port, HKM02B-4K6G supports audio embedding and extraction through additional ports.

Digital/Analog Audio Conversion

The HKM02BT-4K6G and HKM02BR-4K6G both have 3.5mm audio input and output interfaces, supporting audio embedding, extraction, and other audio functions..

**HKM02BT-4K6G**



**HKM02BR-4K6G**



Bidirectional Audio Transmission

Please note that bi-directional audio transmission is only supported in “Unicast Mode” (and transmitter’s audio input has to be connected).

**Transmit Mic Audio to PC**

When a Mic device connects to the HKM02BR-4K6G via "Mic in," the sound of the Mic can be transmitted to the PC via the "Audio Output" port on the HKM02BT-4K6G. Connect “Audio Output” from HKM02BT-4K6G to the computer’s “Line in” interface via a 3.5mm cable, and you can transmit the remote Mic sound to the computer for communication or recording.

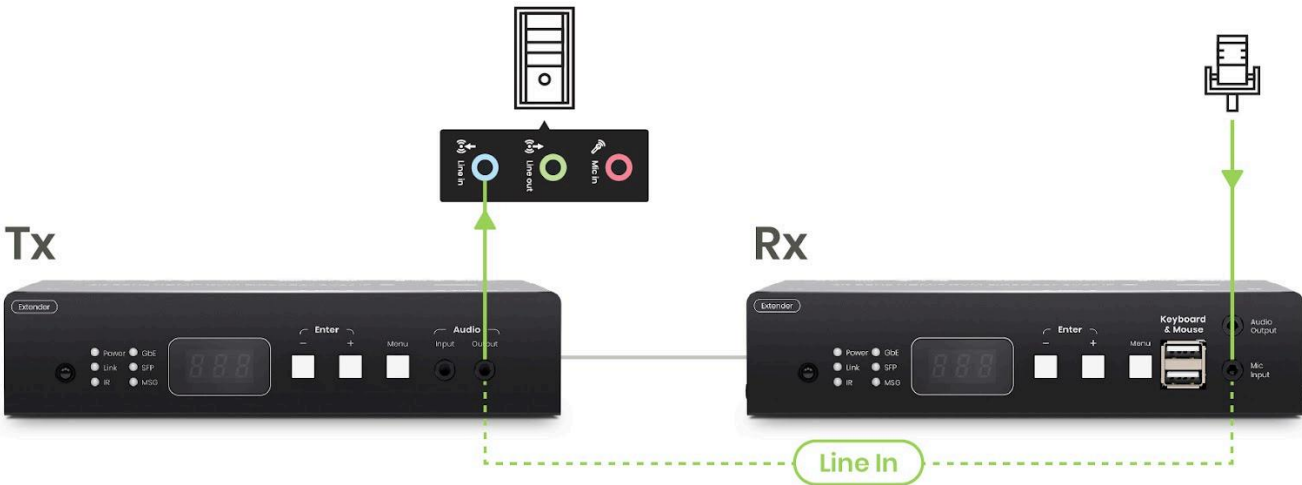

**Play Mic Audio on the HKM02BT-4K6G**

When a Mic device connects to the HKM02BR-4K6G via "Mic in," the sound of the Mic can be played on a speaker connected to the HKM02BT-4K6G via the "Audio Output" port.

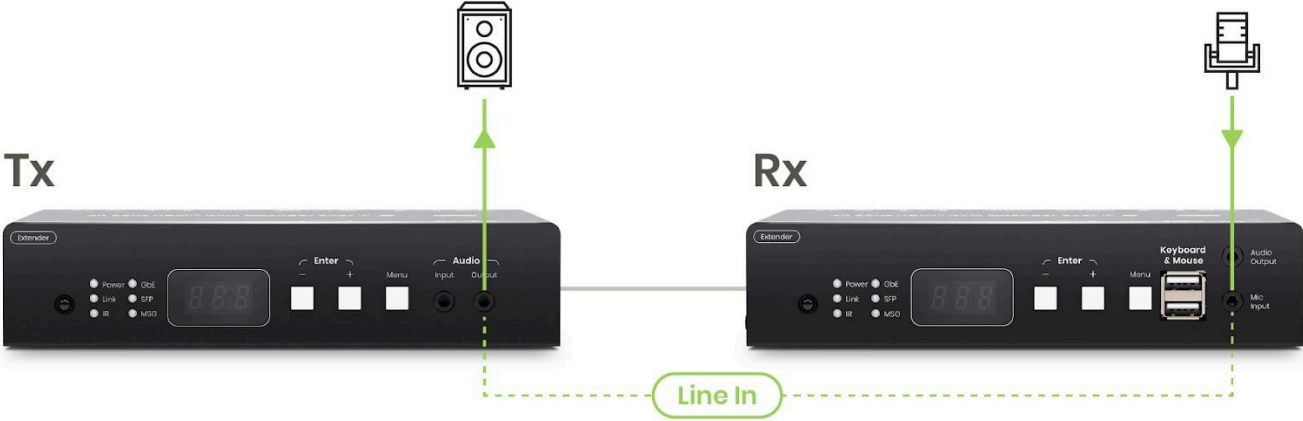

Audio Embedding and Extraction

Audio embedding and extraction can be switched by the following methods:

- 1. Front Panel Buttons (refer to "Control via Front Panel")
- 2. IR Remote (refer to "Control via IR Remote")
- 3. RS232 command (refer to "Control via RS232")

**Audio Embedder**

Play additional audio source on the far end HDMI® screen. When an audio source device is connected to the HKM02BT-4K6G via the "Audio Input", the sound can be played on an HDMI® screen at the HKM02BR-4K6G via the "HDMI® Output" port. You can choose the audio source from either the HDMI digital audio input or the analog audio input.

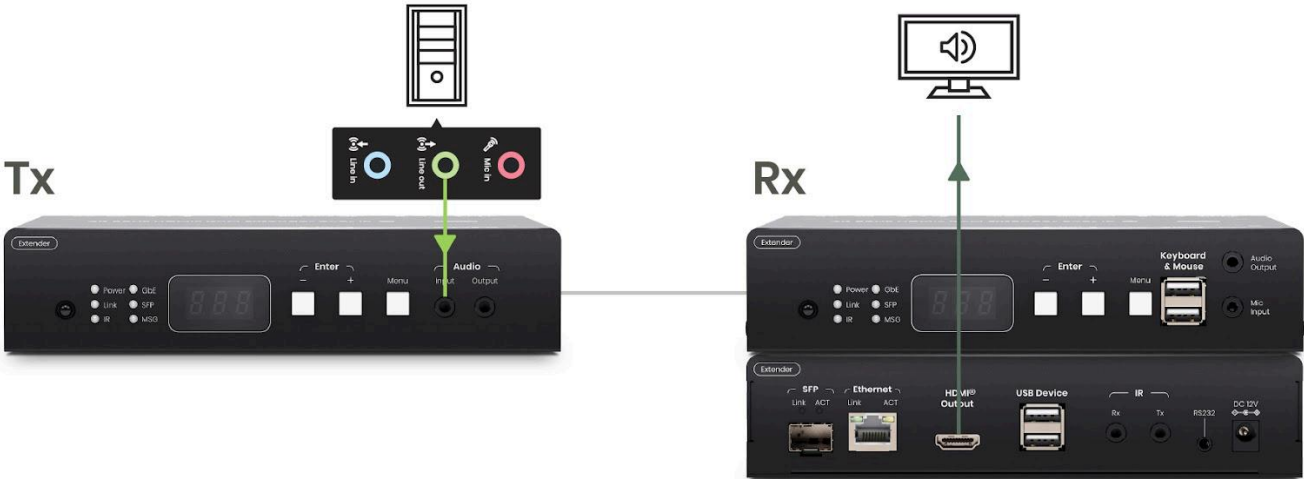

**Audio Extractor**

Far end playing PC Audio Sound.

Play audio on the HKM02BR-4K6G or HDMI® Screen (Audio Extraction):

When the HKM02BT-4K6G only has an “HDMI® in” (without devices connected to “Audio Input”), and a speaker is connected to the HKM02BR-4K6G via “Audio Output,” the sound from “HDMI® in” can be played either on the HDMI® screen or the speaker.



**USB Interface**

In addition to audiovisual data transmission, HKM02B-4K6G supports the transmission of USB signals over IP. This feature allows users to transmit USB 2.0, USB 1.1 and USB 1.0 data between connected devices, such as computers, peripherals, USB storage devices, etc.

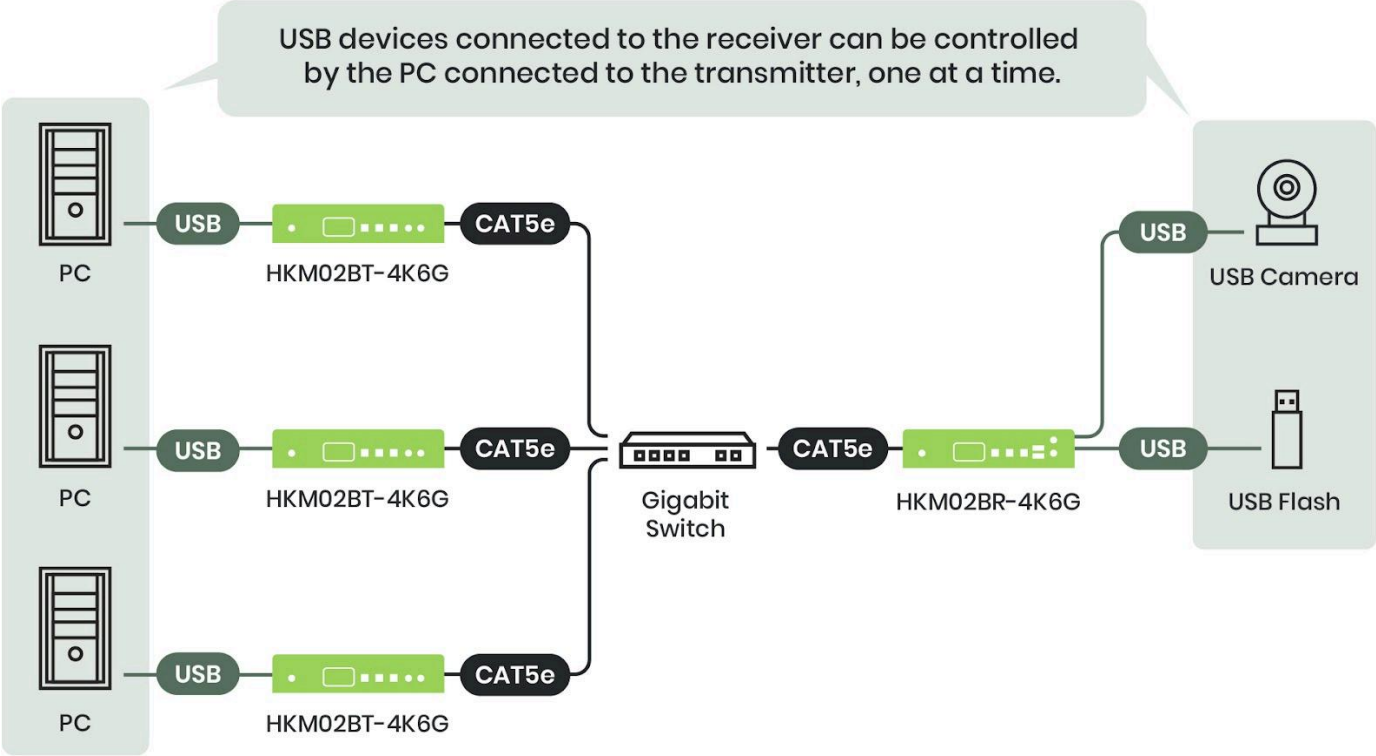

**Read and write speed**

HKM02B-4K6G uses four-pair STP/UTP cable to enable high-speed USB data transfer over a CAT5e cable or higher. The read and write speed via HKM02B-4K6G/direct transfer between USB host and USB device is shown as follows:



(Results may vary with devices from different manufacturers.)



## USB Compatibility

HKM02B-4K6G complies with USB 2.0<sup>4</sup>, it is backwards compatible with USB 1.1 and USB 1.0, and support all USB transfer types<sup>5</sup>. However, it's not certain that it will work with every USB device or host because different factors can affect how USB devices perform over long distances.

HKM02B-4K6G is compatible with a variety of communication protocols and device types, allowing it to send different kinds of data including files, sound, picture, and input from devices like mice, keyboards, and touchpads that connect via USB cable or Bluetooth.

HKM02B-4K6G supports one upstream port and 14 downstream ports with configurable endpoint type.





## USB Storage

While in Multicast communication mode, plug-and-play is supported for multiple USB keyboards and mouses on each receiver.

But for USB storage devices, the transmitter can only recognize such devices attached on one receiver at a time. For the transmitter to switch to USB storage devices connected to another receiver, there are two methods explained in the following steps:

1. Hot key: Press "Pause/Break" key three times on the keyboard connected to the receiver where the USB storage device is attached



2. IR Remote or Panel Buttons control: Press the     buttons (Starting USB) directing to the receiver where the USB storage device is attached

---

<sup>4</sup> Standard USB 2.0 supports speeds up to 480 Mbps.

<sup>5</sup> Control Transfers : Typically used for command and status operations, along with bulk, interrupt and isochronous transfers. Bulk Transfers : Used for transmission of large quantities of data, typically by mass storage devices, cameras that generate compressed video streams, and other devices that require fast file transfers.

Interrupt Transfers : Used by devices, such as keyboards and mice.

Isochronous Transfers : Used by time-sensitive devices such as streaming cameras and audio products.

**USB Power Output**

Max power output for USB devices is 5V/0.5A on HKM02BR-4K6G.

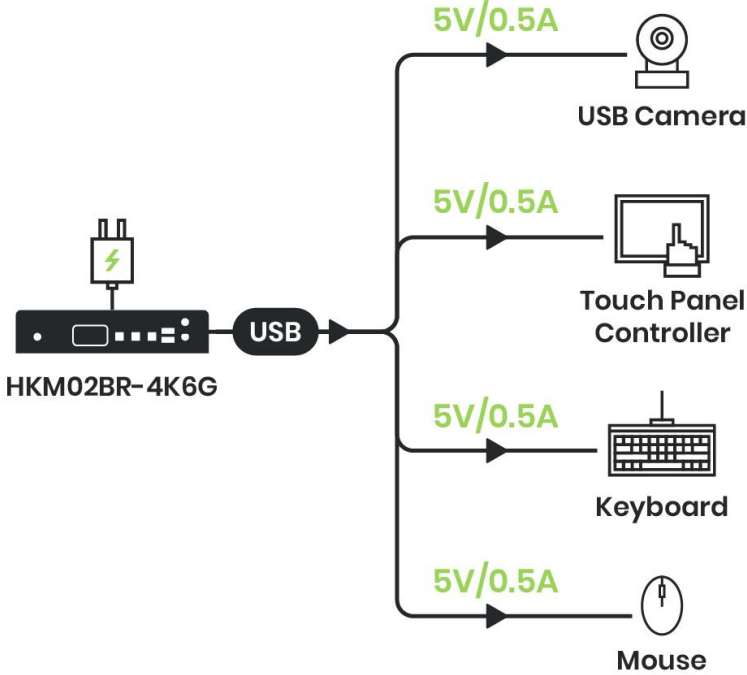

## RS232 Interface

### RS232 Passthrough

HKM02B-4K6G supports RS232<sup>6</sup> control, used for connecting various electronic devices. It defines the electrical characteristics and timing of signals for serial communication between devices<sup>7</sup>, typically facilitating communication between computers and peripherals such as modems, printers, and other serial devices.

For successful communication, both communicating devices must operate at the same baud rate<sup>8</sup>. If one device transmits at a different baud rate than the other, communication errors may occur.

Lower baud rates are often chosen for longer communication distances and improved resistance to noise interference. In certain environments, a lower baud rate is preferred to ensure stable communication.

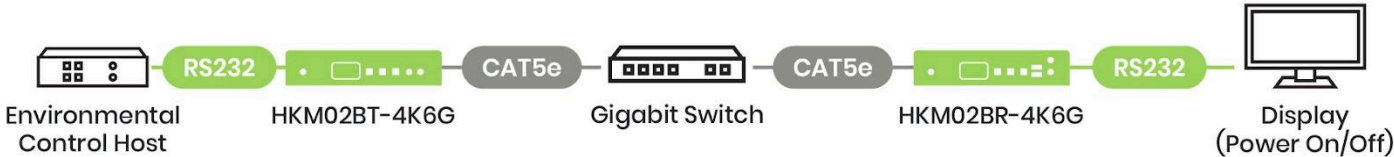

<sup>6</sup> RS232 is used for serial communication, allowing data to be transmitted one bit at a time over a single wire.

<sup>7</sup> RS232 communication can be simplex (one-way), half-duplex (two-way, but only one direction at a time), or full-duplex (two-way, simultaneous communication).

<sup>8</sup> Common baud rates in RS232 communication include 2400, 4800, 9600, 19200, 38400, 57600, 115200, and more. The selection of baud rate depends on the capabilities and requirements of the communicating devices.

Receiver control via RS232

Multiple receivers can be controlled by a single RS232 host. You only need to connect one transmitter to your RS232 host, and the RS232 host can control all the receiver units through the Ethernet switch. For the RS232 commands please refer to the **Command List of Control via RS232** section.

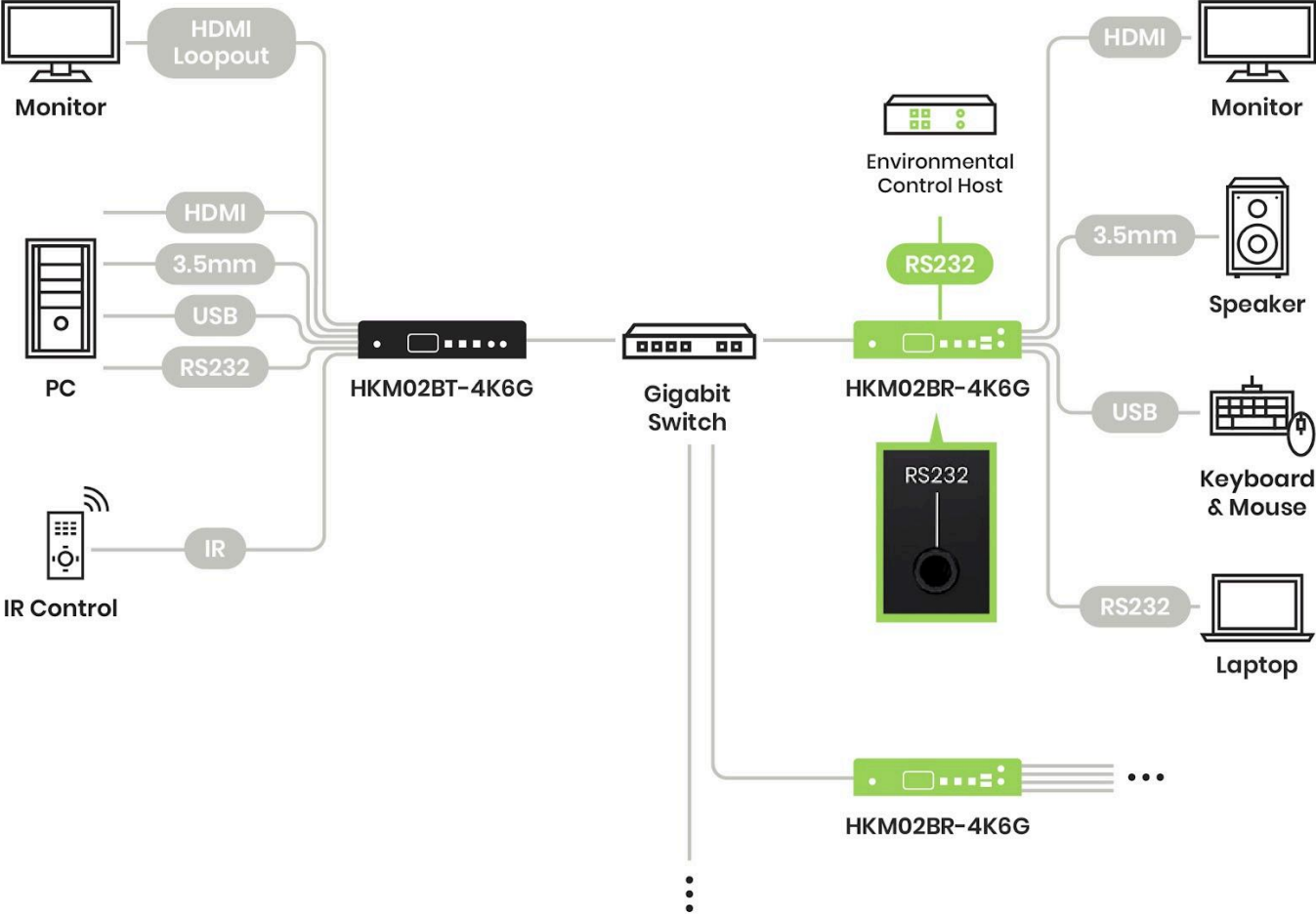

### Infrared (IR) Interface

This function facilitates the transmission of IR signals from an IR remote control to the IR Receiver connected to either the HKM02BR-4K6G or HKM02BT-4K6G. The signal is then passed over IP to the corresponding HKM02BT-4K6G or HKM02BR-4K6G, which is equipped with an IR emitter cable. The IR signal is then emitted to control external devices such as DVD players, TVs, or set-top boxes.

HKM02B-4K6G has a built-in IR interface. You can choose to use the built-in IR receiver or connect an external IR receiver. Once you connect an external IR receiver, the built-in IR will be deactivated.

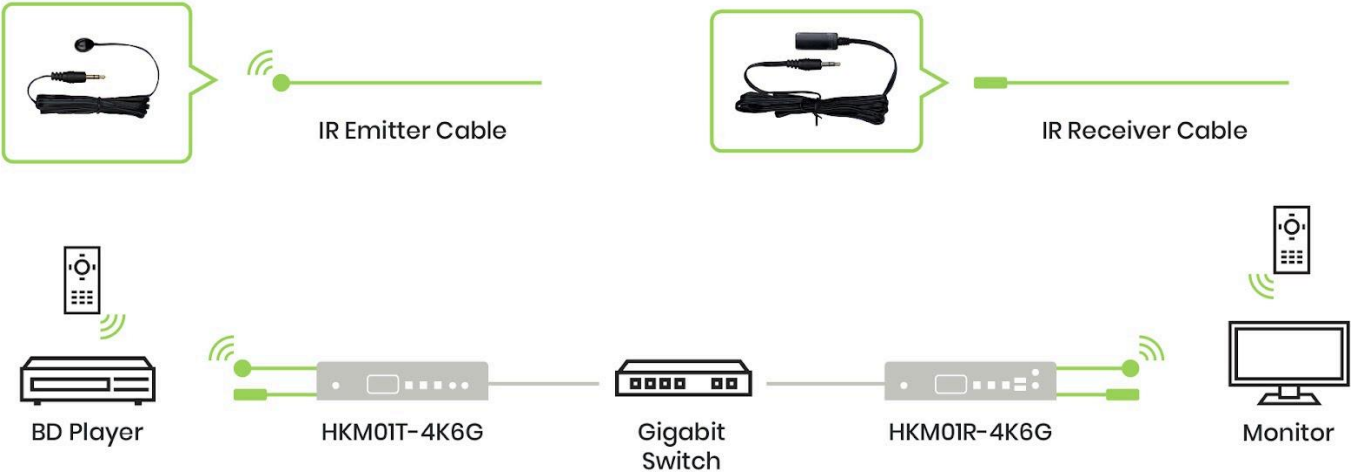

(Refer to the *Control via IR Remote* section.)

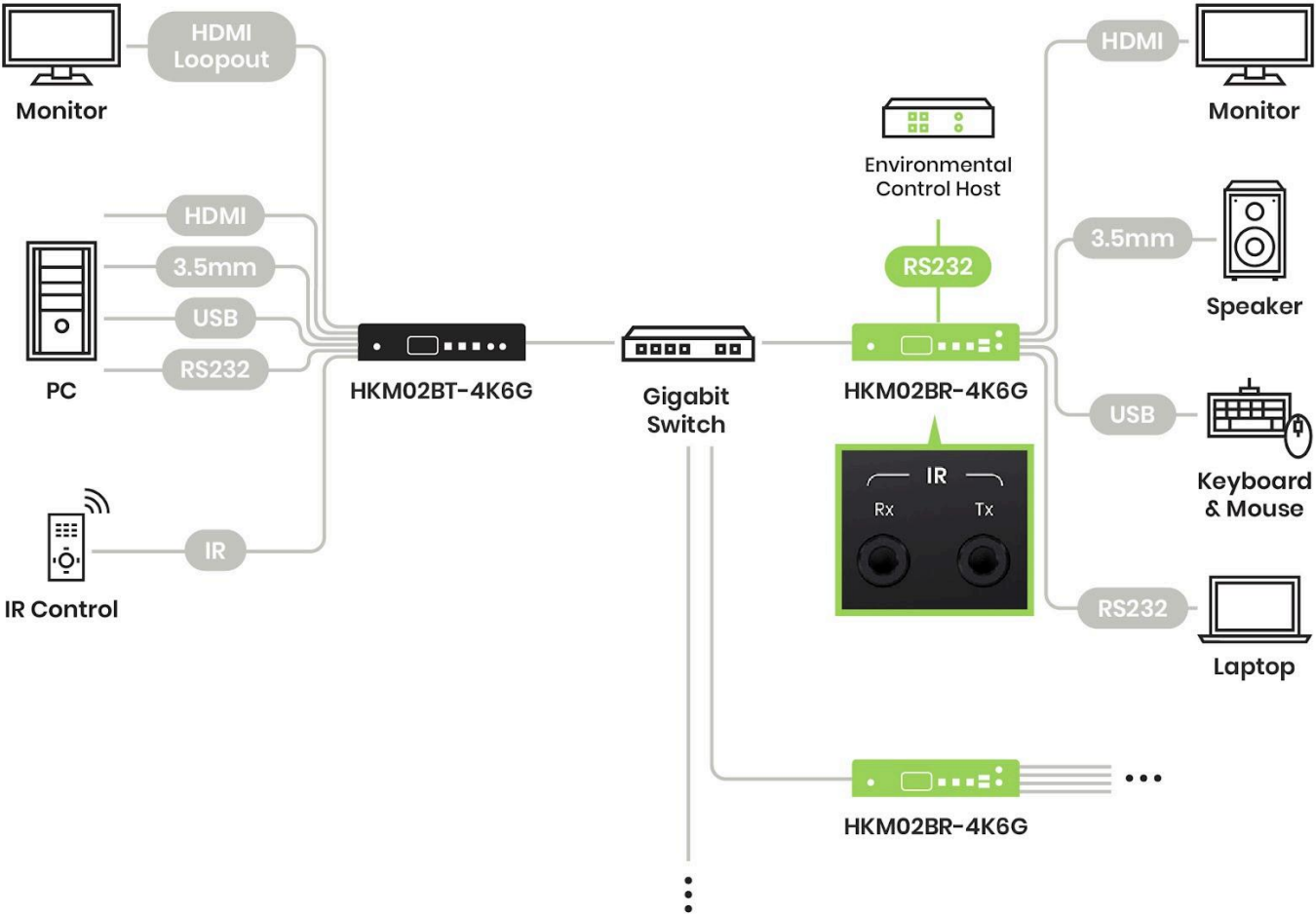

### Control via Front Panel Buttons

#### Function Description

##### Channel Selection

- Short pressed separately: +(Decrease Number) / -(Increase Number)
- Long pressed separately (1~3 seconds): +(Carry, increment one digit) / -(Decomposition, decrement one digit)
- When press\_+ or -, the buttons would light up, indicating the channel is ready to change.

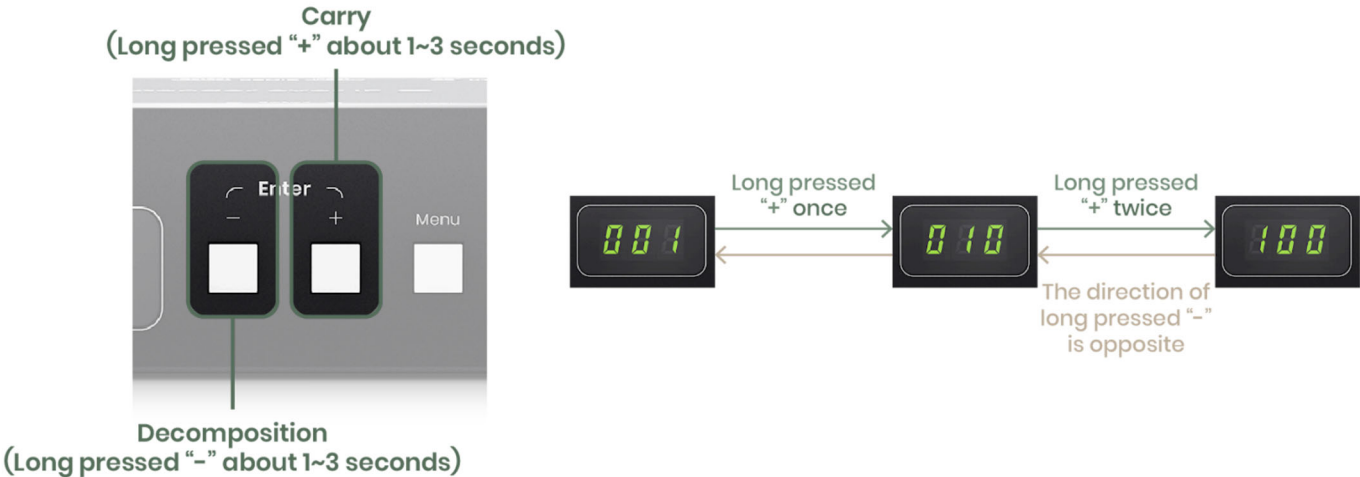

- Short pressed at same time: Enter

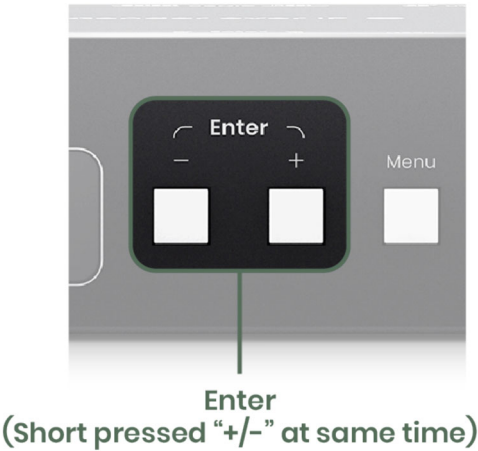

- Press and hold, then power on: +(Factory Default) / -(Engineering Mode)

### Menu Selection

- Short pressed: Menu/Cancel
- Long pressed (3 seconds): Lock/Unlock Button(after long pressing for the lock function, the buttons on the front panel are disabled, but the channel can still be switched via RS232 or IR Remote, and the display panel will show the channel)

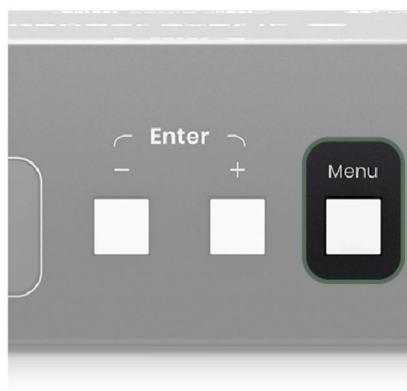

**Lock/Unlock All Buttons:**  
Long pressed "Menu" about 3 seconds)

- The menu function list refers to "**OSD Menu Function List**" in control via IR Remote chapter
- Press and hold, then power on: Set Factory Default then enter Engineering Mode



### Button Function List

Button	-	+	Menu
Short Press	Reduce Number	Increase Number	Menu/Cancel
	Enter		
Press 1 seconds	Carry	Decomposition	
Press 3 seconds	N/A	N/A	Lock/Unlock Button(When no OSD menu)
Press and hold then power on	Factory Default	Engineering Mode	Set Factory Default then enter Engineering Mode

- Reduce Number: switches channel or function number down
- Increase Number: switches channel or function number up
- Carry: shifts the three numbers in display one position to the left
- Decomposition: shifts the three numbers in display one position to the right
- Press the panel buttons “-” and “+” together to turn on the video output of the receiver when it is off.

**Note: In engineering mode, Power and Link LEDs will flash simultaneously. The unit's IP address will be temporarily set to the Static IP 169.254.0.88. Users can log in to the web page via a browser to update the firmware.**

## Control via IR Remote





### Function Description



You can use the IR remote for configuration or to switch channels. Simply point the IR Remote at the IR receiver next on the front panel next to the power LED indicator or at the external IR receiver.

### Setting up the IR Remote ID





To control the devices using the IR Remote, you need to set the IR remote's ID:

- To control the transmitter, set the IR Remote ID to 7. Hold down , then press .
- To control the receiver, set the IR Remote ID to 8. Hold down , then press .

**Note:**

- Reconfigure the IR remote's ID the first time you use the IR remote or after replacing the IR Remote's batteries.
- When setting up the IR Remote's ID, ensure that the IR remote is not in a location where the device can receive its signal. This prevents the transmitter or the receiver from entering standby mode while holding down the Power button on the IR remote.

### Channel Selection

- Method 1: Use     to select the channel, the press  to switch to the selected channel.
- Method 2: Directly enter the channel number then press  to confirm.







### Menu Selection

- Method 1: First press , then use     to select the menu item, then press

 to confirm

- Method 2: First press , then enter the menu item number, then press  to confirm





### Enter/Exit Quick Blocking Mode

- Press    to enter IR Quick Blocking Mode  
When multiple devices (transmitters or receivers) are placed together, using the IR remote to set up devices can cause confusion in the settings operation. Entering IR Quick Blocking Mode will prevent devices from accepting IR remote commands.
- Press    to exit IR Quick Blocking Mode  
You can also use the IR hotkey or press any button on the front panel to exit IR Quick Blocking Mode. Once the Quick Blocking Mode is deactivated, you can use the IR remote to manage the devices.



### Screensaver wake-up

- When the receiver enters screensaver mode, you can exit the screensaver mode by pressing any button on the IR Remote or the panel buttons

### Add/Remove Favorite List for Receiver

- To add the current channel to the list of favorite channels (up to 32 favorite channels), press , then press .
- To remove the current channel from the list of favorite channels, press , then press .

### Videowall/General Mode switching for Receiver

- To quickly switch between videowall and General mode for convenient preview and setup, press , then press .

### Turn on/off video output of Receiver

- Press  to turn on/off the video output of the receiver.





- When turned off, you can also press the panel buttons - and + to turn on the video output of the receiver.

**Connection/Disconnection of Transmitter**

- Press  to connect or disconnect the transmitter.

**RS232 OSD Display for Transmitter**







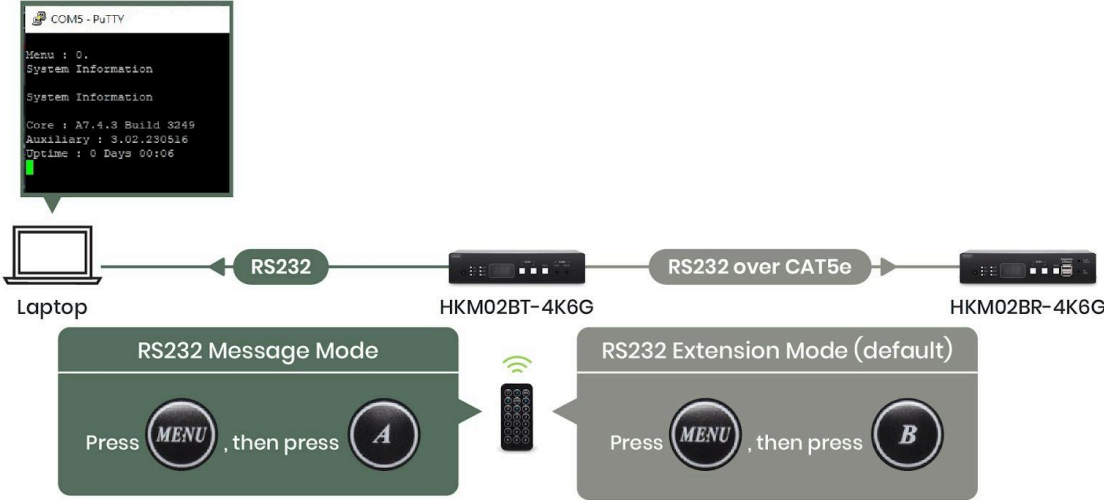











Since the transmitter does not have an OSD display, you can use the following method to switch to RS232 message mode, allowing the transmitter to deliver RS232 messages to the connected computer.

- Press , then press  to switch to RS232 message mode.
- Press , then press  to switch back to RS232 extension mode (default mode).

**Note: this function does not automatically reset upon reboot, you must manually switch between message and extension modes.**



### Basic Button Function List

Symbol	Button	Receiver Function	Transmitter Function
	POWER	Turn Off/On Video Output Setup Remote's ID	Connect/Disconnect Receiver
	MENU	Menu selection, input numbers after press menu button	
	UP	Increase Value	
	DOWN	Reduce Value	
	LEFT	Carry	
	RIGHT	Decomposition	
	ENTER	Enter / Show Channel Information (When no other Menu operation)	Enter
	ASTERISK	Cancel	
	NUMBER	Recall Previous Value	
	A	Favorite Channel Switching	Set RS232 to Auxiliary Mode to Receive Menu Message
	B	Back to Previous Channel	Set RS232 to Extender Mode
	1	Number 1	
	2	Number 2	
	3	Number 3	
	4	Number 4	
	5	Number 5	
	6	Number 6	
	7	Number 7	

	8	Number 8
	9	Number 9
	0	Number 0

## Advanced OSD Menu Function List

The OSD Menu Function List can be controlled via Front Panel Buttons and IR Remote. The steps for controlling the OSD Menu are described in the previous sections.

No.	Menu	Description	Option / Remark	Rx	Tx
0	System Information	System Information		V	V
1	Network Information	Network Information		V	V
2	Function Information	Function Information		V	V
3	Control Information	Control Information		V	V
4	Video & Audio Information	Video & Audio Information		V	V
5	RS232 Control Information	RS232 Control Information		V	V
6	Channel Information	Channel Information		V	X
7	Favorites Information	Favorites Information		V	X
8	Routing Information	Routing Information		V	X
9	Video Wall Information	Video Wall Information		V	X
10	Advanced Menu	Display advance menu	0 = Hide 1 = Display	1	1
11	Reconnection	Reconnect with Tx/Rx		V	V
12	Disconnection	Disconnection (keep routing channel)		V	X
13	Stop Connection	Stop all connection (Include routing channel)		V	V
14	Starting USB	Get USB control priority (in multicast mode only)		V	X
15	Casting Mode	Casting Mode setting	0 = Unicast 1 = Multicast	1	1
16	Jumbo Frame	Jumbo Frame setting	0 = Disable	1	1
17	Free Routing	Free Routing setting	1 = Enable	1	1
18	IP mode	IP mode setting	0 = Auto IP 1 = Static 2 = DHCP	1	1

20	Video Function	Video Extender setting	0 = Disable 1 = Enable	1	1
21	Audio Function	Audio Extender setting		1	1
22	USB Function	USB Extender setting		1	1
23	RS232 Function	RS232 Extender setting		1	1
24	IR Function	IR Extender setting		1	1
25	Video Wall Function	Video Wall setting		1	1
27	Keyboard Mouse Function	Keyboard Mouse Extender setting		1	1
30	Button Control	Button Control setting	0 = Disable 1 = Enable	1	1
31	Button Lock	Button Lock		0	0
32	IR Control	IR Control setting		1	1
33	IR Control ID	IR Control ID setting	0 ~ 9 = IR Control ID 10 = User Define Controller	8	7
34	RS232 Control	RS232 Control setting	0 = Disable 1 = Enable (Case Sensitive) 2 = Case Insensitive	1	1
41	Scaler Output Mode	Video output resolution setting	0 = Pass-Through 1 = Pass-Through (Strict) 2 = Auto Detect (Per EDID) 3 = Full HD 1080p 60Hz 4 = Full HD 1080p 50Hz 5 = Ultra HD 2160p 60Hz 6 = Ultra HD 2160p 50Hz 7 = Ultra HD 2160p 30Hz 8 = Ultra HD 2160p 25Hz 9 = Ultra HD 2160p 24Hz 10 = Customize	2	X
42	Audio Select	Tx Audio Input Select /Rx Audio Output Select	0 = Digital 1 = Analog 2 = Auto	2	2
43	Analog Input Volume	Analog Input Volume	0 = Mute 1 ~ 100 = Volume %	85	85
44	Analog Output Volume	Analog Output Volume		85	85
45	Video Quality	Video Quality setting	0 = Graphic Mode 1 ~ 5 = Mode 1 ~ 5 6 = Video Mode	X	6
46	Anti-Dither	Anti-Dither setting	0 = Disable 1 ~ 2 = Mode 1 ~ 2	X	0



47	EDID Update	Update EDID from Tx or monitor of Rx		V	V
48	EDID Select	Select default EDID of Tx	0 = Default HDMI 1 = Default DVI 2 = Default VGA	X	0
50	RS232 Select	RS232 Port Mode Select	0 = Disable 1 = Extender 2 = Keypad 3 = Auxiliary 4 = Console	1	1
51	RS232 Baudrate	RS232 Extender Baudrate	0 = 115200 bps 1 = 57600 bps 2 = 38400 bps 3 = 19200 bps 4 = 9600 bps 5 = 4800 bps 6 = 2400 bps 7 = 1200 bps 8 = 600 bps 9 = 300 bps	0	0
52	RS232 Newline	RS232 Control Newline setting	0 = Linux (0x0A) 1 = Windows (0x0D, 0x0A)	1	1
53	RS232 Trigger	RS232 Control Trigger setting	2 = Mac (0x0D) 3 = Other (0x0A, 0x0D)	1	1
54	Auxiliary Baudrate	Auxiliary Baudrate	0 = 115200 bps 1 = 57600 bps 2 = 38400 bps 3 = 19200 bps 4 = 9600 bps 5 = 4800 bps 6 = 2400 bps 7 = 1200 bps 8 = 600 bps 9 = 300 bps	0	0
55	Auxiliary Newline	Auxiliary Newline setting	0 = Linux (0x0A) 1 = Windows (0x0D, 0x0A)	1	1
56	Auxiliary Trigger	Auxiliary Trigger setting	2 = Mac (0x0D) 3 = Other (0x0A, 0x0D)	1	1
57	Device No	Device No. for RS232 control	0 ~ 999	0	X
58	Group No	Group No. for RS232 control	0 ~ 99	0	X

59	Party No	Party No. for RS232 control		0	X
60	Fast Switch	Switch without stop link	0 = Disable	1	1
61	Conflict Check	Check existing Tx channel	1 = Enable	X	1
62	Channel Name	Display Channel Name	0 = Hide 1 = Display	0	X
63	Only Favorites	Only Favorites Channel Available	0 = Disable 1 = Enable	0	X
64	Lock Favorites	Lock Favorites Channel		0	X
65	Auto Sort Favorites	Auto Sort Favorites Channel		0	X
66	Sort Favorites	Sort Favorites Channel	Immediately sort favorite channel	V	X
67	Scan Channel To Favorites	Scan Channel To Favorites		V	X
70	Direct Access Menu	Run menu function even hide	0 = Disable 1 = Enable	1	1
71	Menu Item "Advanced Menu"	Display/Hide "Advanced Menu"		1	1
72	Screensaver	Screen Saver setting		0	X
73	Turn off by IR operation	Behavior After turn Off	0 = No Option 1 = Mute Analog Audio 2 = Stop Connection	1	X
74	Diagnostic Information	Diagnostic Information	0 = Disable 1 = Enable	1	X
75	Message Redirect	Message Redirect to Auxiliary		X	1
76	Command Redirect	Command Redirect to Auxiliary		1	1
80	Video Routing	Video Routing setting	0 ~ 999 = Specific Channel 1000=Follow Channel	1000	X
81	Audio Routing	Audio Routing setting		1000	X
82	USB Routing	USB Routing setting		1000	X
83	RS232 Routing	RS232 Routing setting		1000	X
84	IR Routing	IR Routing setting		1000	X
86	GPIO Routing	GPIO Routing setting		1000	X
87	Load Routing Mapping	Load Free Routing Mapping	0~3	V	X
88	Save Routing Mapping	Save Free Routing Mapping		V	X
90	Video Wall Max Row	Rows of Video Wall(Vertical)	0~7 (0=row 1, 1=row 2...)	0	X

91	Video Wall Max Column	Columns of Video Wall(Horizontal)	0~15 (0=column 1, 1=column 2)	0	X
92	Monitor Row Position	Monitor Position in Row	0~7	0	X
93	Monitor Column Position	Monitor Position in Column	0~15	0	X
94	Monitor Outside Width	Outer Width of Monitor	0~65000 (0.1mm)	0	X
95	Monitor Outside Height	Outer Height of Monitor		0	X
96	Monitor Viewable Width	Width of Viewable Area		0	X
97	Monitor Viewable Height	Height of Viewable Area		0	X
100	Stretch Type	Screen Stretch Type	0 = Auto 1 = Stretch Out 2 = Fit In	2	X
101	Rotate	Screen Rotation and Mirror	0 ~ 7	0	X
102	Vertical Shift	Screen Vertical Shift	400 = Default 399 ~ 0 = shift up 401 ~ 801 = shift down	400	X
103	Horizontal Shift	Screen Horizontal Shift	400 = Default 399 ~ 0 = shift left 401 ~ 801 = shift right	400	X
104	Vertical Scale	Screen Vertical Scale	0 ~ 200 (scaling too large cause blink )	0	X
105	Horizontal Scale	Screen Horizontal Scale		0	X
106	Load Video Wall	Load Video Wall Setting	0~15	V	X
107	Save Video Wall	Save Video Wall Setting		V	X
200	Backup Setting	Backup Setting to bank 0~3	0 ~ 3	V	V
201	Restore Setting	Restore Setting from bank 0~3		V	V
202	System Setting	System Setting	0~255 (Debug use, no recommend for general users)	V	V
203	Application Setting	Application Setting		V	V
333	Reset To Default	Reset to factory default		V	V
999	System Reboot	System Reboot		V	V

**V = Available X = Not available Numbers = default value**

**Notes:**

- **Menu 17** The free routing function only works in multicast mode.

- 
- **Menu 22** Disabling the USB extender function will also disable the keyboard and mouse extender function (Menu 27).
  - **Menu 25** Display or hide TV wall settings in the WebGUI.
  - **Menu 27** You can disable keyboard and mouse extender function if there is any compatibility issue, then it will use the USB extender function instead.
  - **Menu 33** To customize the ID of the IR remote, you need to import it to the receiver via RS232 or telnet command.
  - **Menu 41**
    - Pass-Through: Used with Fast Switch function. The output resolution follows the one before switching, if it does not meet the requirement for Fast Switch function, the switching time will still be longer than expected. The strict Pass-Through mode will preserve the same color space and color depth, while the regular Pass-Through mode will force the color space to RGB.
    - Auto Detect (Per EDID): The output resolution follows the EDID of the monitor connected to the receiver.
    - Customize: The output resolution can be customized via RS232 command or WebGUI
  - **Menu 47** In multicast mode, restore default EDID for the transmitter, or copy the monitor's EDID to the receiver.
  - **Menu 50**
    - Extender: RS232 extender mode
    - Keypad: connect to RS232 keypad or use the computers' terminal
    - Auxiliary = auxiliary or debug mode
    - Console = system console debug
  - **Menu 60** Fast switching only works when the resolution, frame rate, scan mode(interlace/progressive), color depth, color space, HDCP version are the same.
  - **Menu 61** When enabled, the transmitter will, after rebooting, check if the current channel number is already assigned to another transmitter, if so, the transmitter will automatically disconnect.
  - **Menu 75** Since the transmitter side cannot display the current OSD menu on the screen, you can use the message redirecting from RS232.
  - **Menu 76** Command redirecting runs RS232 command from Web or telnet port.
  - **Menu 80~86** Only available when free routing is enabled.
  - **Menu 90~107** Only available when videowall function is enabled.
  - **Menu 200** Will not back up the parameters saved by \*107 Save Video Wall.
  - **Menu 333** Will clear all parameters saved by \*107 Save Video Wall.

## Control via RS232

### Function Description

In RS232 extender mode, the RS232 port of the transmitter can be used to configure and operate the transmitter and the receivers that are set to the same channel with the transmitter. The configuration and operation can be achieved with a default baudrate of 115200 bps (8-N-1, no flow control) via software programs such as HyperTerminal.

The command format is defined as follows: >CMD ADDRESS> COMMAND PARAMETERS

- Address and parameters are in HEX code. Press Enter to execute the command.
- All receivers whose address matches the command address will execute the corresponding command. Besides the MAC and IP address, there are three additionally parameters that can also be used for addressing:
  - Device Number
  - Group Number
  - Party Number
- The address format of the receiver is explained as follows:

Format	Description	Example
Mxxxxxx	Last 6 digits of the MAC address of the receiver	2218688612AB = M8612AB
Ixxxx	The third and the fourth octet of the IP address of the receiver	169.254.012.034 = I0C22
Dxxx	Device No	Device No 123 = D123
Gxx	Group No	Group No 12 = G12
Pxx	Party No	Party No 12 = P12
Cxxx	Channel No	Channel 123 = C123
ALL	All receivers	-
Tx	Current transmitter connected to the RS232 port	-
Rx	Current receiver connected to the RS232 port	-

The reply format is defined as follows: <ACK\_ADDRESS< REPLY MESSAGE

- The receiver replies with a message as defined above, using either the MAC or IP address. If a command is sent to multiple receivers (addressing via Group No, Party No, Channel No, or all receivers), these will not reply with any message.

- Example:
  - >CMD\_M8612AB> CHANNEL 12  
(Set receiver which last 6 digits of MAC Address 8612AB to Channel 12)
  - <ACK\_M8612AB< OK  
(Receiver with the last 6 digits of MAC Address 8612AB replies with “OK”)

Note: It is recommended to configure the RS232 routing of all receivers to a single transmitter to avoid disconnections during channel switching.

## Command List

Command	Parameters	Description	Remark
CHANNEL	?	Show current channel number	Transmitter not support parameter NAME Receiver not support parameter CHECK
	[ 0~999 ]	Switch to specified channel	
	[ 0~999 ] NAME ?	Check current channel name	
	[ 0~999 ] NAME "string"	Set channel name, 28 character MAX	
	NAME ?	Show channel name setting	
	NAME [ ENABLE   DISABLE ]	Enable/disable channel name	
	NAME CLR	Clear all channel name	
	NAME IMPORT	Import channel name	
	FAST ?	Status of current fast switch	
	FAST [ ENABLE   DISABLE ]	Enable/disable fast switch	
	CHECK ?	Status of channel conflict check	
	CHECK [ ENABLE   DISABLE ]	Enable/disable channel conflict check	
FAVORITE	?	Usage of favorite channel (MAX.32)	Transmitter not support parameter FAVORITE
	ADD	Add current to favorite channel	
	ADD [ 0~999 ]	Add specified channel to favorite	
	DEL	Delete current from favorite channel	
	DEL [ 0~999 ]	Delete specified channel from favorite	
	CLR	Clear favorite channel list	
	ONLY ?	Status of favorite channel only	
	ONLY [ ENABLE   DISABLE ]	Enable/disable favorite channel only	
	AUTO ?	Status of auto sort favorite channel	
	AUTO [ ENABLE   DISABLE ]	Enable/disable auto sort favorite	
SORT	Sort favorite channel immediately		
VIDEO	FUNC ?	Status of video extension	Transmitter not support parameter ROUTING, SCALER, CUSTOMIZE, RESUME, PAUSE, and BLACK Receiver not support parameter QUALITY and DITHER
	<b>FUNC [ ENABLE   DISABLE ]</b>	Enable/disable video extension	
	ROUTING ?	Status of video routing	
	ROUTING [ FOLLOW   0~999 ]	Set video routing follow or specified	
	SELECT ?	Status of video input / output mode	
	<b>SELECT [ 0~2 ]</b>	Set input / output, 0=DVI, 1=VGA, 2=DVI+VGA	
	SCALER ?	Status of video output resolution	
	SCALER [ 0~4   5 ]	Set output resolution, 5=customize	
	CUSTOMIZE ?	Status of customize resolution	
	<b>CUSTOMIZE integer</b>	Set customize resolution	
	QUALITY ?	Status of video quality	
	QUALITY [ 0   1~5   6 ]	Set video quality	
	DITHER ?	Status of video dither	
	DITHER [ 0   1~2 ]	Set video dither	
	EDID	Update EDID from Tx or monitor of Rx	
	RESUME	Resume stream	
PAUSE	Pause stream		
BLACK	Stop stream and send black screen		
VIDEOWALL	FUNC ?	Status of video wall function	Transmitter support

	FUNC [ ENABLE   DISABLE ]	Enable/disable video wall	FUNC only
	MODE ?	Status of video wall mode	
	MODE [ ENABLE   DISABLE ]	Set video wall mode/single mode	
	LOAD 0~15	Load video wall setting (all)	
	LAYOUT 0~15	Load video wall layout (MAX Row/MAX Column/Row/Column)	
	SAVE 0~15	Save video wall setting (video wall parameters with GROUP, PARTY and CHANNEL settings.)	
	OW ?	Show outer width of monitor	
	OW [ 0~65535 ]	Set outer width of monitor	
	OH ?	Show outer height of monitor	
	OH ? [ 0~65535 ]	Set outer height of monitor	
	VW ?	Show width of viewable area	
	VW ? [ 0~65535 ]	Set width of viewable area	
	VH ?	Show height of viewable area	
	VH ? [ 0~65535 ]	Set height of viewable area	
	MAX_ROW ?	Show maximum row of video wall	
	MAX_ROW 0~7	Set the row 1~8 of video wall	
	MAX_COLUMN ?	Show maximum column of video wall	
	MAX_COLUMN [ 0~15 ]	Set the column 1~16 of video wall	
	ROW?	Show position in row	
	ROW [ 0~7 ]	Set position in row	
	COLUMN ?	Show position in column	
	COLUMN [ 0~15 ]	Set position in column	
	STRETCH ?	Status of stretch type	
	STRETCH [ 0~2 ]	Set stretch, 0 = Auto, 1 = Stretch Out, 2 = Fit In	
	ROTATE ?	Status of rotate type	
	ROTATE [ 0~7 ]	Set rotate, 0 = default	
	SHIFT_V	Status of vertical shift	
	SHIFT_V [ 0~399   400   401~801 ]	0~399: up, 400:default, 401~801: down	
	SHIFT_H ?	Status of horizontal shift	
	SHIFT_H [ 0~399   400   401~801 ]	0~399: up, 400:default, 401~801: down	
	SCALE_V ?	Status of vertical scale	
	SCALE_V [ 0~255 ]	Set vertical scale	
	SCALE_H ?	Status of horizontal scale	
	SCALE_H [ 0~255 ]	Set horizontal scale	
	ENABLE %1_%2_%3_%4	%1 = MAX_ROW, %2 = MAX_COLUMN, %3 = ROW, %4 = COLUMN	
	MONITOR_INFO %1_%2_%3_%4	%1 = VW, %2 = OW, %3 = VH, %4 = OH	
AUDIO	FUNC ?	Status of audio extension	Transmitter not support parameter ROUTING
	<b>FUNC [ ENABLE   DISABLE ]</b>	Enable/disable audio extension	
	ROUTING ?	Status of audio routing	



	ROUTING [ FOLLOW   0~999 ]	Set audio routing follow or specified	
	SELECT ?	Status of audio setting	
	SELECT [ 0~2 ]	Select audio of Tx input or Rx output (0=Digital, 1=Analog, 2=Auto)	
	IN ?	Status of audio input volume	
	IN [ 0   1~100 ]	Set audio input volume (%), 0 = Mute	
	OUT ?	Status of audio output volume	
	OUT [ 0   1~100 ]	Set audio output volume (%), 0 = Mute	
USB	FUNC ?	Status of USB extension	Transmitter not support parameter ROUTING and REQUEST
	<b>FUNC [ ENABLE   DISABLE ]</b>	Enable/disable USB extension	
	ROUTING ?	Status of USB routing	
	ROUTING [ FOLLOW   0~999 ]	Set USB routing follow or specified	
	REQUEST	Request USB access (multicast only)	
	KM FUNC ?	Status of keyboard mouse extension	
	<b>KM FUNC [ ENABLE   DISABLE ]</b>	Enable/disable keyboard mouse extension	
RS232	FUNC ?	Status of RS232 extension	Transmitter not support parameter ROUTING
	<b>FUNC [ ENABLE   DISABLE ]</b>	Enable/disable RS232 extension	
	ROUTING ?	Status of RS232 routing	
	ROUTING [ FOLLOW   0~999 ]	Set RS232 routing follow or specified	
	SELECT ?	Status of RS232 setting	
	SELECT [ 0~4 ]	0=Disable, 1=Extender, 2=Keypad, 3=Auxiliary, 4=Console	
	CTRL ?	Status of RS232 control setting	
	CTRL [ 0~2 ]	0=disable, 1=enable, 2=insensitive	
	BAUD ?	Status of baud rate	
	<b>BAUD [ 0~9 ]</b>	0=115200, 1=57600, 2=38400... 9=300	
	NEWLINE ?	Status of newline format	
	NEWLINE [ 0~3 ]	0=Linux, 1=Windows, 2=Mac, 3=Other	
	TRIGGER ?	Status of trigger	
	TRIGGER [ 0~3 ]	0=Linux, 1=Windows, 2=Mac, 3=Other	
IR	FUNC ?	Status of IR extension	Transmitter not support parameter ROUTING
	<b>FUNC [ ENABLE   DISABLE ]</b>	Enable/disable IR extension	
	ROUTING ?	Status of IR routing	
	ROUTING [ FOLLOW   0~999 ]	Set IR routing follow or specified	
	CTRL ?	Status of IR control setting	
	CTRL [ ENABLE   DISABLE ]	Enable/disable IR control	
	ID ?	Status of IR remote ID	
	ID [ 0~10 ]	Set IR remote ID	
	KEY [ 0~32 ] ?	Status of IR key setting	
	KEY [ 0~32 ] = address, command	Set mapping of third party IR remote command	
	KEY IMPORT	Import IR key setting	
	BLOCK ?	Status of IR quick block	
	BLOCK [ ENABLE   DISABLE ]	Enable/disable IR quick block	

BUTTON	CTRL ?	Status of button control	
	CTRL [ ENABLE   DISABLE ]	Enable/disable button control	
	LOCK ?	Status of button lock	
	LOCK [ ENABLE   DISABLE ]	Enable/disable button lock	
HDCP	?	Status of HDCP Always On	
	0~2	0=Disable, 1=HDCP 1.4, 2=HDCP 2.2	
EDID	UPDATE	Update EDID from monitor of Rx	Transmitter not support parameter UPDATE, only Receiver not support parameter SELECT and Mode
	SELECT ?	Status of Tx default EDID setting	
	SELECT [ 0~3 ]	0=HDMI, 1=DVI, 2=VGA	
	MODE ?	Status of EDID process	
	MODE [ 0~1 ]	0=normal, 1= Patch EDID	
HDMI	CTRL ?	Status of HDMI 5V control	Transmitter not support parameter CTRL
	CTRL [ ENABLE   DISABLE ]	Enable/disable HDMI 5V control	
SCREEN	?	Status of screen settings	Transmitter not support this command
	[ ON   OFF ]	Screen on/off	
	SAVER ?	Status of screen saver	
	SAVER [ ENABLE   DISABLE ]	Enable/disable screen saver	
	OPTION ?	Status of behavior after screen off	
	OPTION [ 0~2 ]	Set behavior after screen off	
OSD	ON "string"	Show "string" on screen (30 seconds)	Transmitter not support this command
	OFF	Turn off OSD immediately	
	OFF ?	Status of OSD duration (ms)	
	OFF [ 0~65535 ]	Set duration of OSD (ms)	
ROUTING	?	Status of free routing	Transmitter not support parameter LOAD and SAVE
	[ ENABLE   DISABLE ]	Enable/disable free routing	
	LOAD [ 0~3 ]	Load free routing setting	
	SAVE [ 0~3 ]	Save free routing setting	
DEVICE	?	Status of device number	Transmitter not support this command
	[ 0~999 ]	Set device number	
GROUP	?	Status of group number	Transmitter not support this command
	[ 0~99 ]	Set group number	
PARTY	?	Status of party number	Transmitter not support this command
	[ 0~99 ]	Set party number	
NET	RECONNECT	Reconnect with Tx/Rx	Transmitter not support parameter DISCONNECT
	DISCONNECT	Disconnection (keep routing channel)	
	STOP	Stop all connection (Include routing channel)	
	MULTICAST ?	Status of multicast	
	MULTICAST [ ENABLE   DISABLE ]	Disable=unicast	
	JUMBO_FRAME ?	Status of Jumbo Frame	
	JUMBO_FRAME [ ENABLE   DISABLE ]	Enable/disable Jumbo Frame	
IP_MODE ?	Status of IP mode		

	<b>IP_MODE [ 0~2 ]</b>	0=Auto, 1=static, 2=DHCP	
	IP ?	Status of static IP address	
	<b>IP [ xxx.xxx.xxx.xxx ]</b>	Set static IP address	
	NETMASK ?	Status of subnet mask (static IP mode)	
	<b>NETMASK [ xxx.xxx.xxx.xxx ]</b>	Set subnet mask (static IP mode)	
	GATEWAY ?	Status of gateway (static IP mode)	
	<b>GATEWAY [ xxx.xxx.xxx.xxx ]</b>	Set gateway (static IP mode)	
QUERY	IP	Status of current IP address	
	MAC	Status of MAC address	
	RESOLUTION	Status of video resolution	
	VERSION	Status of firmware version	
AUXILIARY	BAUD ?	Status of auxiliary baudrate	
	BAUD [ 0~9 ]	0=115200, 1=57600, 2=38400... 9=300	
	NEWLINE ?	Status of auxiliary newline	
	NEWLINE [ 0~3 ]	0=Linux, 1=Windows, 2=Mac, 3=Other	
	TRIGGER ?	Status auxiliary trigger	
	TRIGGER [ 0~3 ]	0=Linux, 1=Windows, 2=Mac, 3=Other	
	VERSION	Status of auxiliary versions	
LOAD	<b>DEFAULT</b>	Load default to current setting	
	<b>[ 0~3 ]</b>	Load system setting from bank 0~4	
SAVE		Save current system setting	
	[ 0~3 ]	Save system setting to bank 0~4	
REBOOT		Reboot	
CONSOLE	string	Run console API command	For debug using, if input incorrect values will cause unpredictable problems, adjust by professional installer only.
SYSTEM	[ 0~255 ] ?	Status of system function	
	[ 0~255 ]	Set system function	
APPLICATION	[ 0~255 ] ?	Status of application function	
	[ 0~255 ]	Set application function	

Notes:

- Backspace, delete, up, down, left, right keys are not supported. If one of these keys is accidentally pressed while typing a command, please enter a newline and re-enter the command and its respective parameters again.
- Parameters with **gray background color** indicate that a reboot is needed for the changes to take effect.
- OSD ON is for displaying the "string" on the screen. There are a few restrictions explained as follows:
  - 30 characters maximum per line
  - 127 characters maximum in total
  - Comma 「,」, colon 「:」, and quotation marks 「"」 are not supported
  - Some characters need to be entered in ASCII HEX code. When entering an ASCII HEX code, it needs to be in the following format: \x##, where ## is the ASCII HEX code. For example:
    - 「newline」 : \x0a
    - 「(」 : \x28

- 「」: \x22

Command Examples

Example 1: Switch to Channel 12 for the receiver with last 6 digits of MAC Address 861234		
ASCII Command	> C M D _ M 8 6 1 2 3 4 > C H A N N E L 1 2	
HEX Command	3E 43 4D 44 5F 4D 38 36 31 32 33 34 3E 20 43 48 41 4E 4E 45 4C 20 31 32 0D 0A	
ASCII Reply	< A C K _ M 8 6 1 2 3 4 < O K	(the receiver with last 6 digits of MAC Address 861234 replies "OK")
HEX Reply	3C 41 43 4B 5F 4D 38 36 31 32 33 34 3C 20 4F 4B 0D 0A	

Example 2: Switch to Channel 3 for the receiver with IP Address xxx.xxx.10.18		
ASCII Command	> C M D _ I 0 A 1 2 > C H A N N E L 3	
HEX Command	3E 43 4D 44 5F 49 30 41 31 32 3E 20 43 48 41 4E 4E 45 4C 20 33 0D 0A	
ASCII Reply	< A C K _ I 0 A 1 2 < O K	(the receiver with IP Address 169.254.10.18 replies "OK")
HEX Reply	3C 41 43 4B 5F 49 30 41 31 32 3C 20 4F 4B 0D 0A	

Example 3: Switch to Channel 5 for receivers with Group No 34		
ASCII Command	> C M D _ G 3 4 > C H A N N E L 5	
HEX Command	3E 43 4D 44 5F 47 33 34 3E 20 43 48 41 4E 4E 45 4C 20 35 0D 0A	
ASCII Reply	(No reply)	
HEX Reply	(No reply)	

Example 4: Display 「Hello! (123) "ABC"」 for all receivers		
ASCII Command	>CMD_ALL> OSD ON "Hello! \x28123\x29 \x22ABC\x22"	

HEX Command	3E 43 4D 44 5F 41 4C 4C 3E 20 4F 53 44 20 4F 4E 20 22 48 65 6C 6C 6F 21 20 5C 78 32 38 31 32 33 5C 78 32 39 20 5C 78 32 32 41 42 43 5C 78 32 32 22 0D 0A
ASCII Reply	(No reply)
HEX Reply	(No reply)

Example 5: Turn off OSD after 10 seconds for all receivers

ASCII Command	> C M D _ A L L > O S D O F F 1 0 0 0 0
HEX Command	3E 43 4D 44 5F 41 4C 4C 3E 20 4F 53 44 20 4F 46 46 20 31 30 30 30 30 0D 0A
ASCII Reply	(No reply)
HEX Reply	(No reply)

Control via Web GUI

System

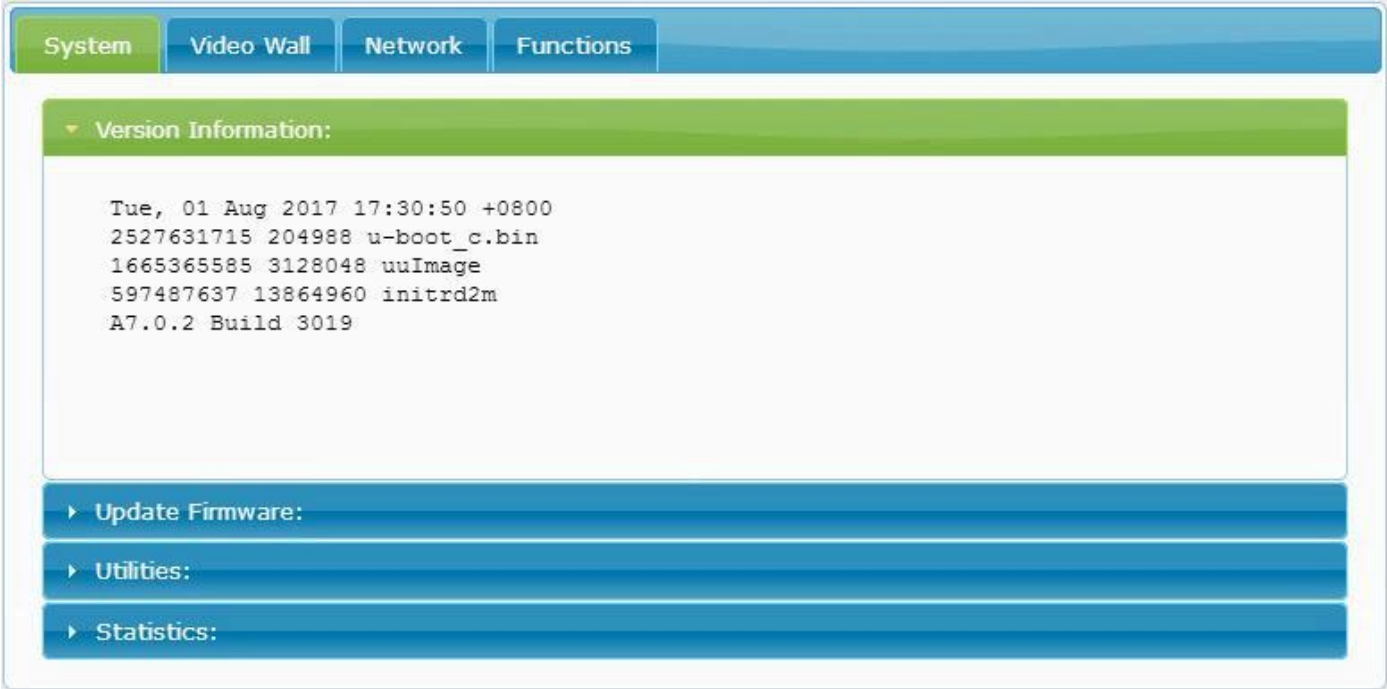

- Console API Command: Runs system API commands for advanced settings.



- Version Information: Display firmware version.
- Update Firmware: Update transmitter/receiver firmware.
- Utilities: Restore factory settings, reboot, and load default EDID or run API commands.

Command	Function Description
Factory Default	Restore Factory Default
Reboot	Reboot
Default EDID	Set up default EDID (Only for Transmitters)
Console API Command	RunAPI command

- Statistics: Display system operating status.

Note: Do not refresh, switch, or close the browser page while updating the firmware using the network, and do not unplug the network cable or cut off the device's power supply before the update progress reaches 100%. This is to avoid causing an update failure that leads to machine damage. Damage caused by firmware update failures is not covered under the warranty.

Video Wall

System Video Wall Network Functions 802.1X

Basic Setup:

### Bezel and Gap Compensation

OW:

OH:

VW:

VH:

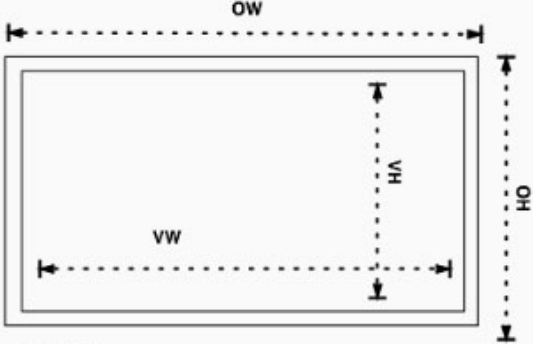

UNIT: 0.1mm

### Wall Size and Position Layout

Vertical Monitor Count:

Horizontal Monitor Count:

Row Position:

Column Position:

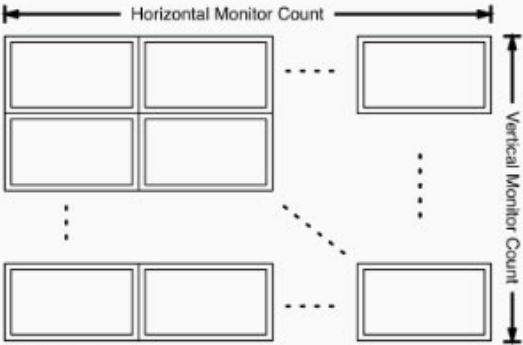

UNIT: Panel

1. Basic Setup
  - 1.1. Bezel and Gap Compensation: Set the screen size, border, and gap dimensions.
    - OW: Screen Outer Frame Width
    - OH: Screen Outer Frame Height
    - VW: Screen Visible Area Width
    - VH: Screen Visible Area Height
  - 1.2. Select the number of vertical and horizontal displays.

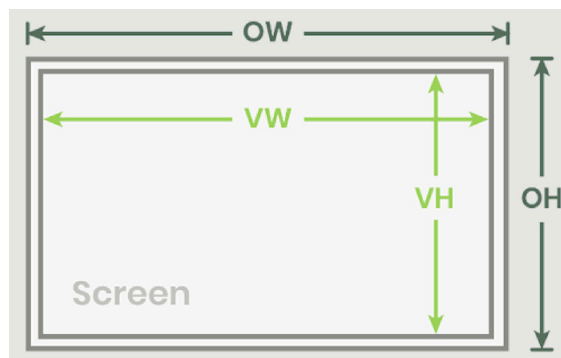

### Wall Size and Position Layout

**Vertical Monitor Count:**

**Horizontal Monitor Count:**

**Row Position:**

**Column Position:**

**Note:**

The width/height of the visible area must be less than the width/height of the frame.

If this function is not used, then keep all values at 0.

The numerical unit is millimeters and must be an integer.

Wall Size and Position Layout: Set the ratio of the video wall and the position of the monitors

Vertical Monitor Count: 1 to 8

Horizontal Monitor Count: 1 to 16

Row Position: 0 to 7

Column Position: 0 to 15

Preferences: Set the extension and rotation

Choose image fill or stretch and rotation angle

Apply To: Apply setting

All: Apply settings to the transmitters and receivers in the list

This (Local): The currently logged-in device

Hosts or Clients: Specify the transmitters or receivers to apply settings to

Show OSD: Display number on OSD  
 Check this box to display the receiver's number on the connected monitors (in list order)



2. Advance Setup

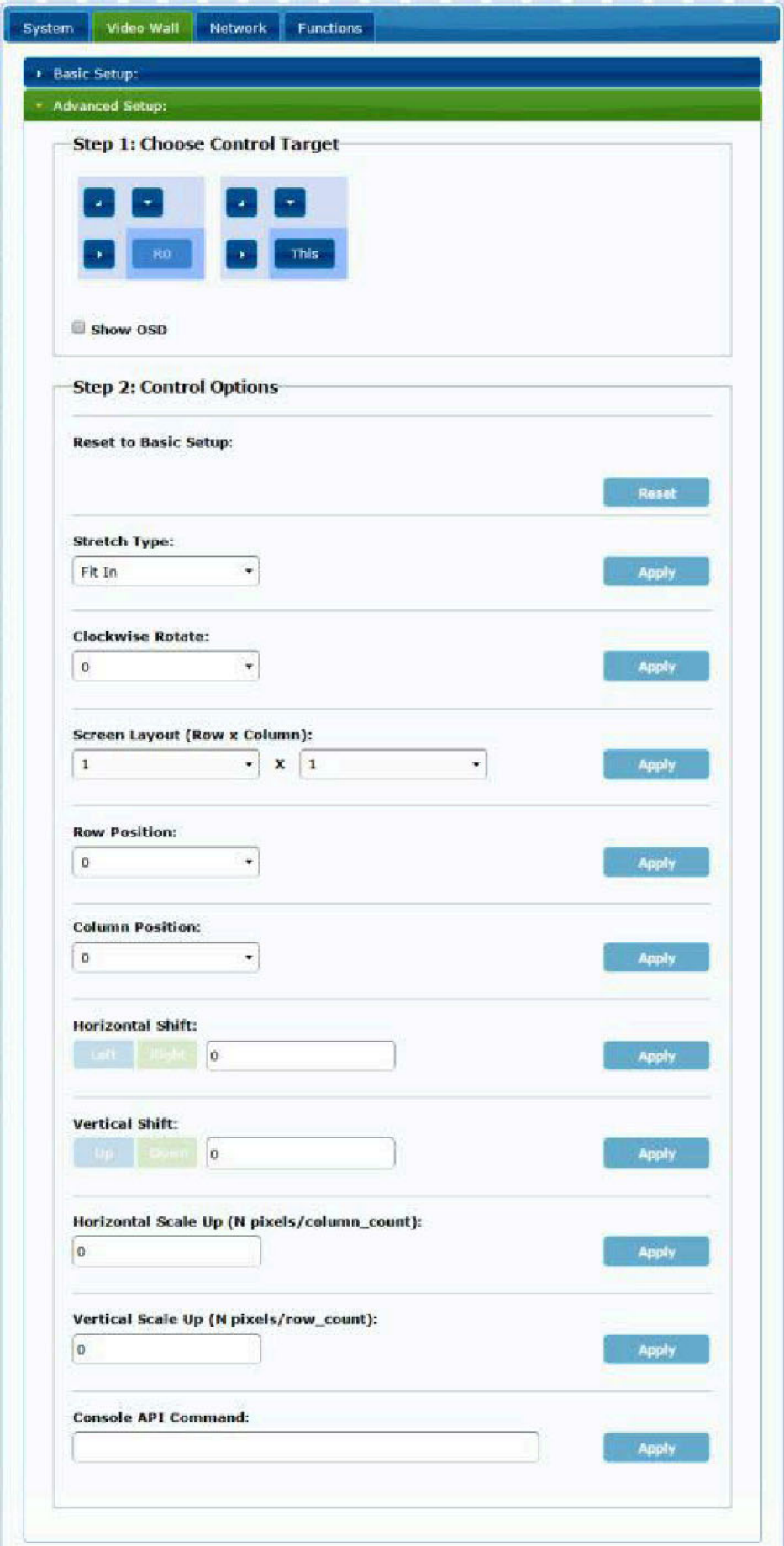

- 2.1. Before entering 'Advanced Settings', please complete the 'Basic Settings'.
- 2.2. Select the target of the video wall you want to control.



- 2.3. Control Options
  - 2.3.1. Reset to Basic Setup:

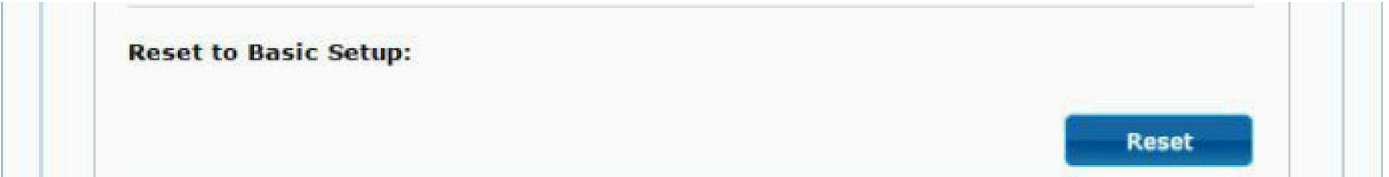

**Note: When an operation error occurs, press 'Reset' to revert to the basic configuration values.**

- 2.3.2. Stretch Type: set the image to 'Fit in' or 'Stretch Out' mode

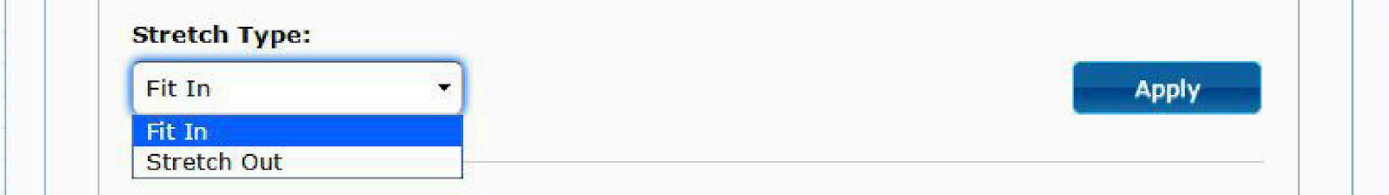

- 2.3.3. Clockwise Rotate: set the rotation angle to 0, 180 or 270 degrees



- 2.3.4. Screen Layout (Row x Column): set the number of vertical and horizontal monitors according to the layout of the videowall. Vertical: 1~8, Horizontal: 1~16.



2.3.5. Row Position: set the monitor's row positions, ranging from 0 to 7

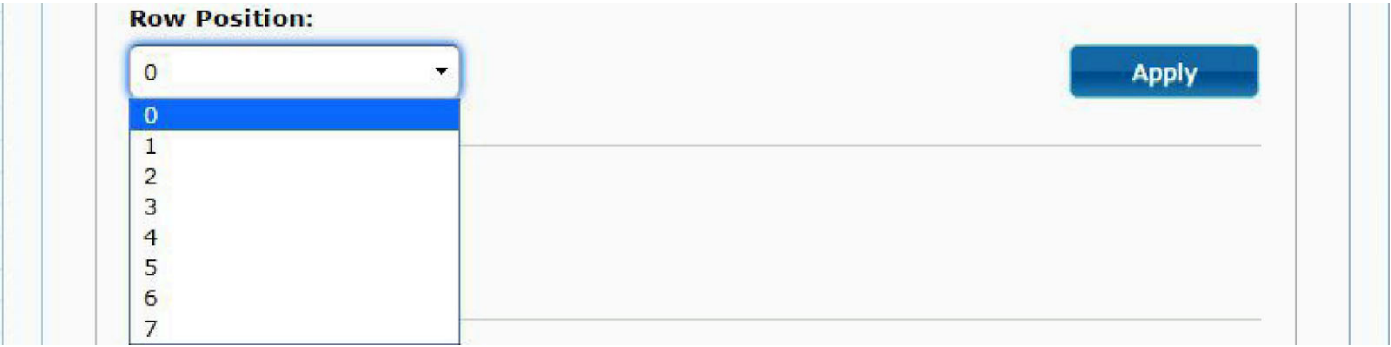

2.3.6. Column Position: set the monitor's column positions, ranging from 0 to 15

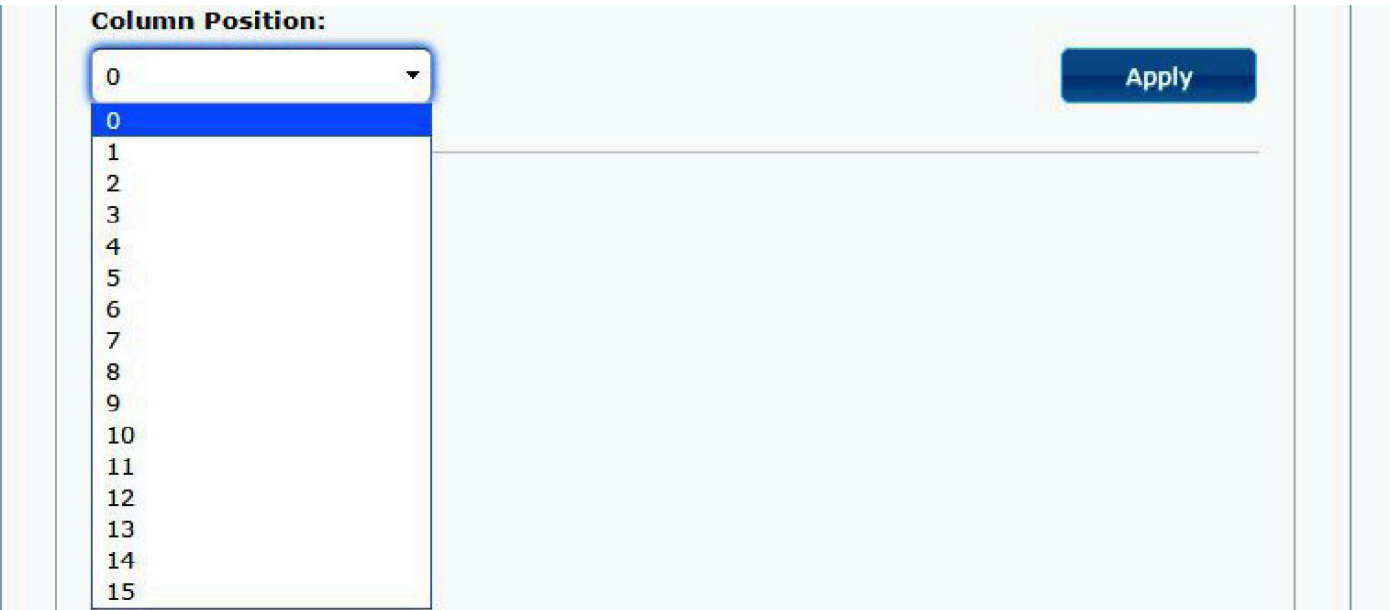

- 2.3.7. Horizontal/Vertical Shift: Shift from Horizontal/Vertical Shift sides.
- 2.3.8. Horizontal/Vertical Scale Up: Scale up/down from Horizontal/Vertical Shift sides.
  - 2.3.8.1. Horizontal Shift: Set the image horizontal shift, moving left or right by pixels.
  - 2.3.8.2. Vertical Shift: Set the image vertical shift, moving up or down by pixels.
  - 2.3.8.3. Horizontal Scale Up: Set the image horizontal scaling by pixels.
  - 2.3.8.4. Vertical Shift Scale Up: Set the image vertical shift scaling ratio, in pixels.

**Horizontal Shift:**

**Vertical Shift:**

**Horizontal Scale Up (N pixels/column\_count):**

**Vertical Scale Up (N pixels/row\_count):**

## Network

The screenshot displays the Network configuration page with a top navigation bar containing 'System', 'Video Wall', 'Network' (highlighted), 'Functions', and '802.1X'. The main content is divided into two sections: 'IP Setup' and 'Casting Mode'. In the 'IP Setup' section, 'IP Mode' is set to 'Static' (highlighted in green), with 'Auto IP' and 'DHCP' also visible. Below this, 'IP Address' is 169.254.6.95, 'Subnet Mask' is 255.255.0.0, and 'Default Gateway' is 192.168.0.1. An 'Apply' button is at the bottom right. The 'Casting Mode' section shows 'Multicast' (highlighted in green) and 'Unicast' as options. A checkbox for 'Auto select USB operation mode per casting mode (recommended)' is checked. An 'Apply' button is also present at the bottom right.

1. IP Setup:
  - IP Mode can be set to three modes: Auto IP, DHCP, or Static. The factory default is Static IP.  
**Note:** In DHCP mode, if there is no DHCP server in the network, the transmitter/receiver will continue to restart until an IP is obtained. You may need to reset the device to factory default settings. (Press the channel button '-' and then turn on the power; the power and LINK LED indicators will flash)
2. Casting Mode (Communication Methods)
  - Can be set to Unicast or Multicast. The default mode is set to multicast.
  - If set to Multicast, it is recommended to select 'Auto select USB operation mode per casting mode' option

## Function

### Transmitter



#### Video over IP Settings

- Recommended setups:
  - Select 'Enable Video over IP'

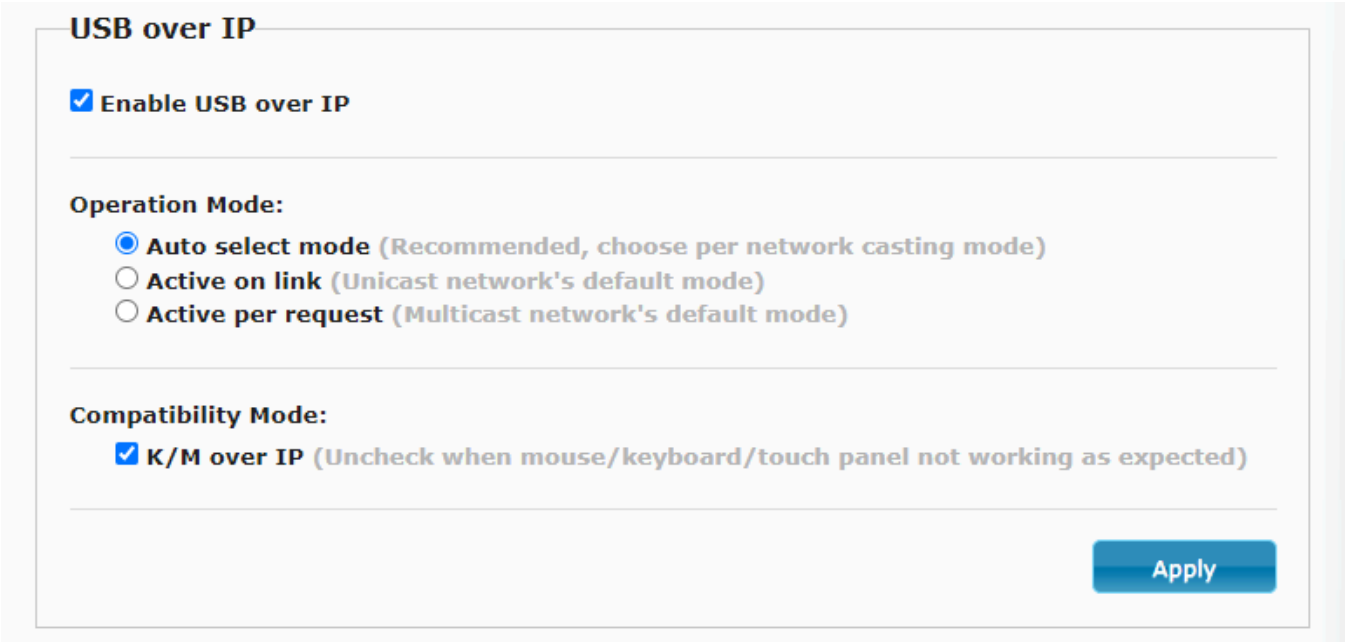

#### USB over IP Settings

- Recommended setups:
  - Select 'Enable USB over IP'
  - Choose Auto Select mode for Operation mode
  - Select 'K/ M over IP for Compatibility Mode'

### Serial over IP

Enable Serial over IP

---

**Operation Mode:**

Type 1 (Need extra control instruction. For advanced usage.)

Type 2 (Recommended. Dumb redirection.)

Type 1 guest mode

Type 2 guest mode

---

**Baudrate Setting for Type 2:**

**Baudrate:**

**Data bits:**

**Parity:**

**Stop bits:**

---

[Apply](#)

#### Serial over IP Settings

- Recommended setups:
  - Select Enable Serial over IP
  - Choose type 2 for Operation Mode
  - Set the baudrate rate into correspondent value

## Receiver

The screenshot displays the 'Functions' tab in the receiver's web interface. The 'Video over IP' section is active, showing several configuration options. At the top, there are navigation tabs: 'System', 'Video Wall', 'Network', 'Functions' (highlighted), and '802.1X'. Below the tabs, the 'Video over IP' section contains the following settings:

- Enable Video over IP**
- Enable Video Wall**
- Copy EDID from this Video Output (Default disabled under multicast mode)**
- Scaler Output Mode:** Full HD 1080p60 (dropdown menu)
- Timeout for Detecting Video Lost + Power Save Timeout is the actual power save time**
- Timeout for Detecting Video Lost:** 10 seconds (dropdown menu)
- Turn off screen on video lost**
- Power Save Timeout:** (empty dropdown menu)

An 'Apply' button is located at the bottom right of the settings area.

### Video over IP Video Settings

- Enable Video over IP: Set whether the video transmission function is enabled.
- Enable Video wall.
- Copy EDID from this Video Output: In Unicast mode, decide whether to copy the EDID of the screen connected to this receiver to the transmitter.
- Scaler Output Mode: Set the image output to a fixed resolution.
  1. 80000004: HD 720p60
  2. 81000061: WXGA 1366x768@60
  3. 81000040: WXGA+ 1440x900@60
  4. 81000051: WUXGA 1920x1200@60
  5. 8100003C: SXGA+ 1400x1050@60
- Timeout for Detecting Video Lost: Set the timeout duration for detecting video loss (do not change the value)
- Turn off screen on video lost: Whether to turn off the screen if video loss timeout occurs (do not check this box).
- Power Save Timeout (do not set this value)



### USB over IP

**Enable USB over IP**

---

**Operation Mode:**

**Auto select mode (Recommended, choose per network casting mode)**

**Active on link (Unicast network's default mode)**

**Active per request (Multicast network's default mode)**

---

**Compatibility Mode:**

**K/M over IP (Uncheck when mouse/keyboard/touch panel not working as expected)**

---

**Apply**

#### *USB over IP Settings*

- Enable USB over IP: Set whether the USB transmission function is enabled. Operation Mode: Set the USB operation mode, it is recommended to choose Auto select mode.
- Compatibility Mode: Set the USB compatibility mode. USB

**Serial over IP**

**Enable Serial over IP**

---

**Operation Mode:**

**Type 1 (Need extra control instruction. For advanced usage.)**

**Type 2 (Recommended. Dumb redirection.)**

**Type 1 guest mode**

**Type 2 guest mode**

---

**Baudrate Setting for Type 2:**

**Baudrate:** 115200 ▼

**Data bits:** 8 ▼

**Parity:** None ▼

**Stop bits:** 1 ▼

---

**Apply**

*Serial over IP Settings*

- Enable Serial over IP: Set whether the RS232 transmission function is enabled.
- Operation Mode: Set the operation mode, the factory default is Type 2.
- Baudrate Setting for Type 2 : The factory default is 115200, 8, None, 1.

Accessory

Compatible with: SR01X - Gigabit Repeater



Features

- Extend the TCP/IP signal additionally, with a distance of up to 120 meters.
- Multiple SR01X units can be daisy-chained for long-distance transmission.
- Bandwidth supports 10/100/1000Mbps.
- Plug and play, easy to install.

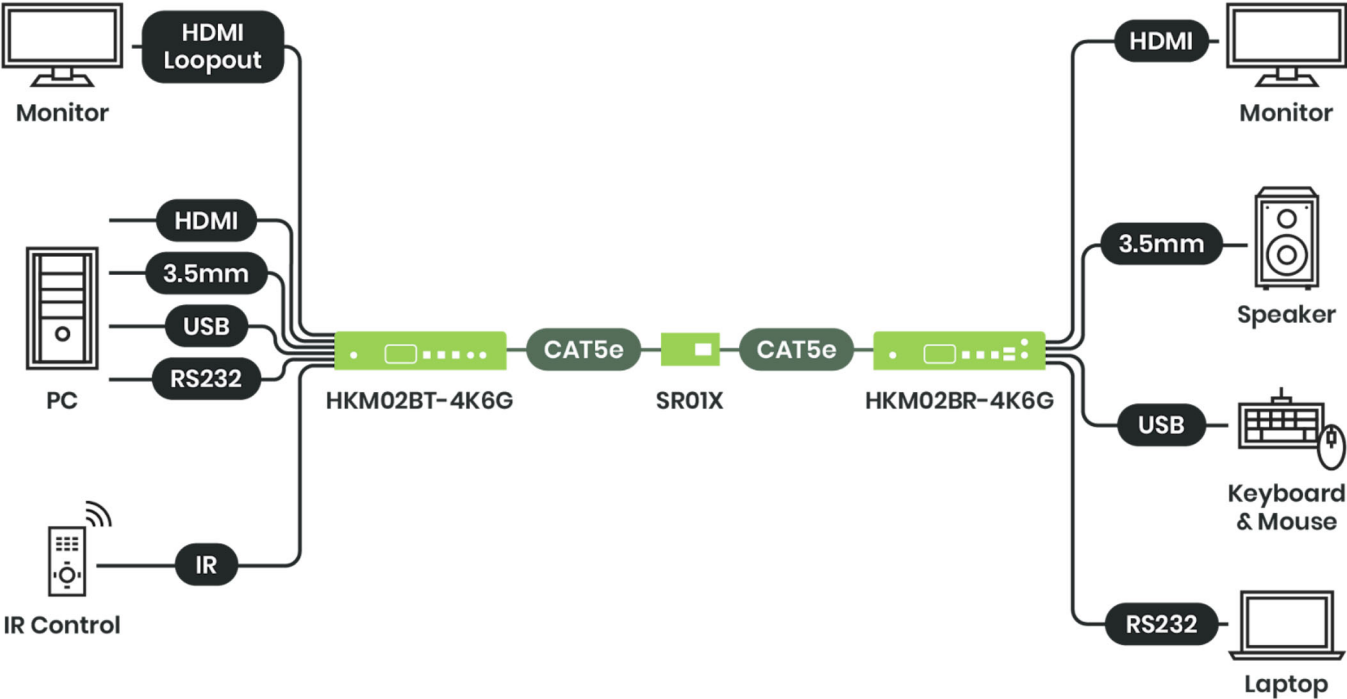

## Keypad: Other Control method



Users can use commercially available RS232 keyboards (Keypad) or the numeric keys of terminal programs to simulate IR remote's operations.

Before use, set **Menu 50 RS232 Select** to Keypad. The RS232 keyboard baud rate can be set by **Menu 54 Auxiliary Baudrate**.

Buttons	Description
「0」 ~ 「9」	Enter number
「+」	Increase digits
「-」	Reduce digits
「.」 or 「#」	Enter last input values of
「Enter」	Confirm enter
「*」 or 「Esc」 or 「Clear」	Cancel enter
「/」	Call menu
Press 「Clear」 4 times · then press 「Enter」	Call menu













